

**GENERAL
CATHOLIC
WORDS**

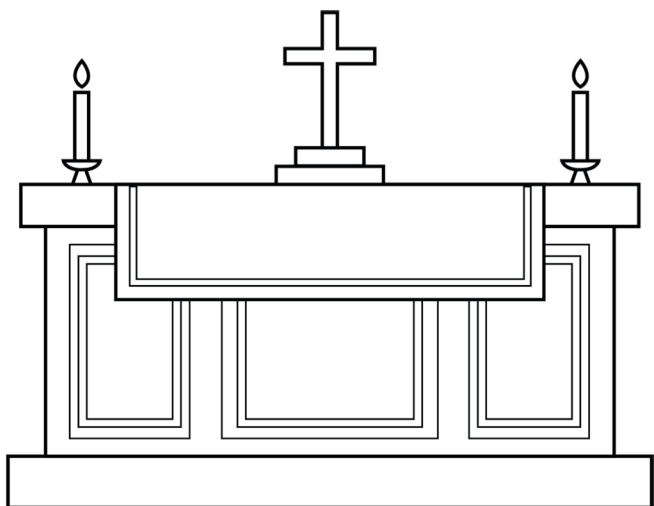

ALTAR

The table of the Eucharist.
The Liturgy of the Eucharist is
celebrated at the altar.

©Adventures of a 4th Grade Classroom

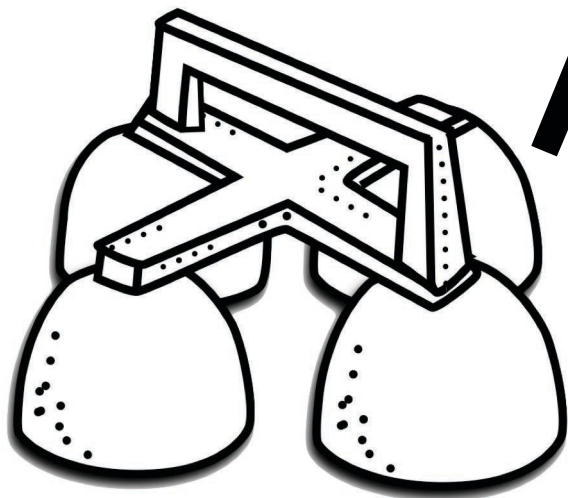

ALTAR BELLS

Bells may be rung shortly before the
consecration. The bells signal the high
point of the mass.

©Adventures of a 4th Grade Classroom

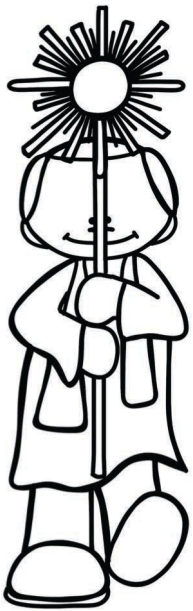

ALTAR SERVER

A person who helps the priest or deacon Mass.
Often this is a young person.

©Adventures of a 4th Grade Classroom



AMBO

The table of the Eucharist. The Liturgy of
the Eucharist is celebrated at the altar.

©Adventures of a 4th Grade Classroom



APOSTLE

One of the twelve men who were called by Jesus to follow him and spread the Word of God. The word apostle means "to send forth" in Greek.

©Adventures of a 4th Grade Classroom



BAPTISM

One of the three Sacraments of Initiation. Baptism gives us new life in God and makes us members of the Church.

©Adventures of a 4th Grade Classroom

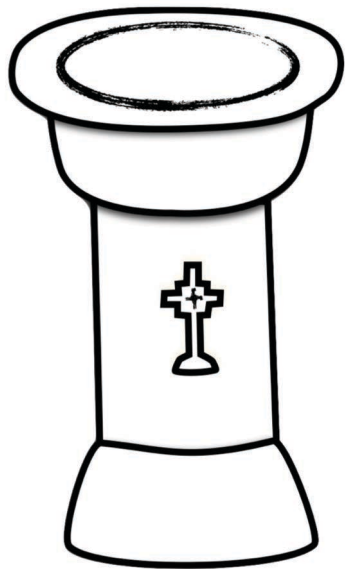

BAPTISMAL FONT

A bowl-shaped container or pool of water used for the sacrament of Baptism.

©Adventures of a 4th Grade Classroom

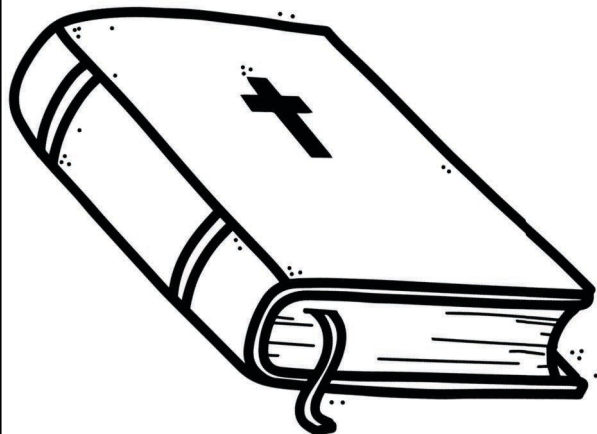

BIBLE

Christian scripture which includes the old testament and new testament. There are 73 books of the bible, including the 4 Gospels- Matthew, Mark, Luke, and John.

©Adventures of a 4th Grade Classroom

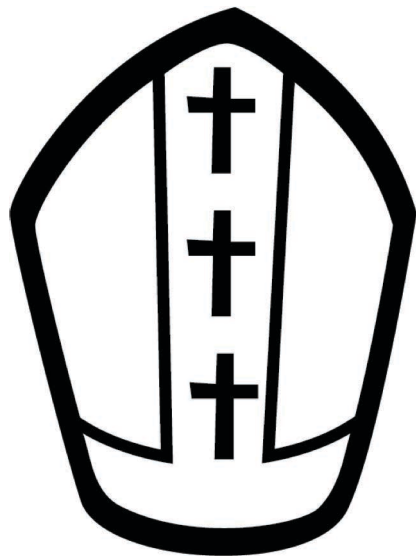

BISHOP

A title given to a priest who holds a special post in the Church, such as being a leader of a diocese or working in the Vatican.

©Adventures of a 4th Grade Classroom

BOOK OF GOSPELS

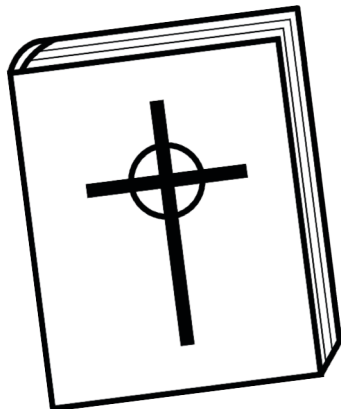

A special book that contains the readings from the four Gospels (Matthew, Mark, Luke, and John) and is used during the Liturgy of the Word.

©Adventures of a 4th Grade Classroom



CANTOR

The leader of song during a mass or other religious celebration.

©Adventures of a 4th Grade Classroom

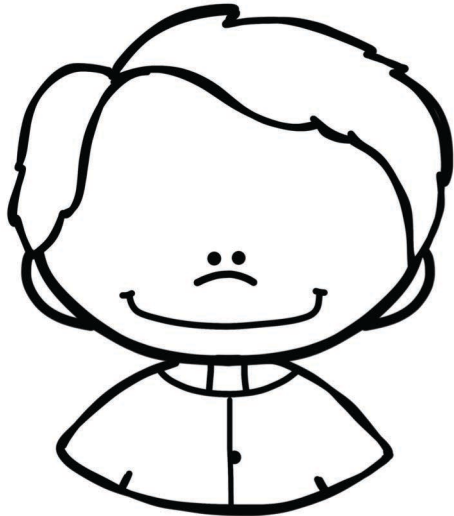

CARDINAL

The highest ranking clergy in the Church, under the pope. They form the College of Cardinals and are in charge of selecting a new pope when necessary.

©Adventures of a 4th Grade Classroom

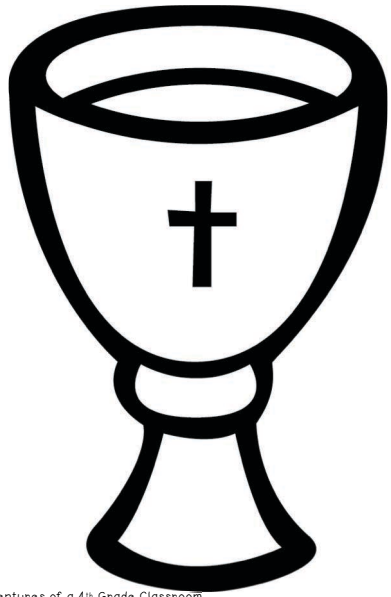

CHALICE

The special cup used at Mass to hold the wine that becomes the Blood of Christ.

©Adventures of a 4th Grade Classroom

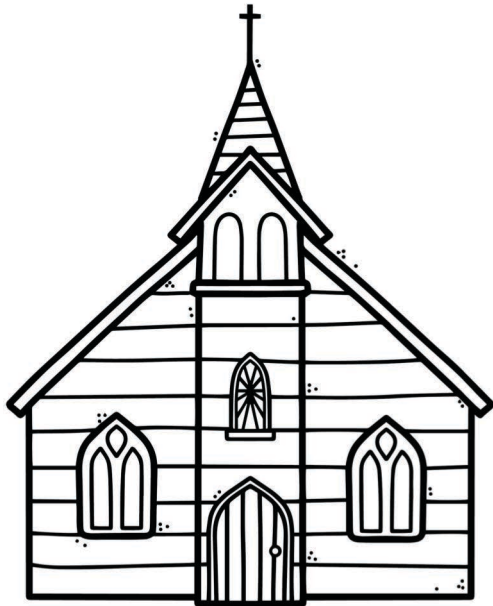

CHURCH

The community of all baptized people who believe in God and follow Jesus. Also, the building where mass is celebrated.

©Adventures of a 4th Grade Classroom



CIBORIUM

The special bowl used at mass to hold the bread that becomes the Body of Christ.

©Adventures of a 4th Grade Classroom

CONCLAVE



The gathering of the College of Cardinals to elect a new pope. All cardinals under age 80 participate in the conclave.

©Adventures of a 4th Grade Classroom

CONFIRMATION



One of the three Sacraments of Initiation. We strengthen our relationship with God through this sacrament and receive the gift of the Holy Spirit.

©Adventures of a 4th Grade Classroom

CONSECRATION

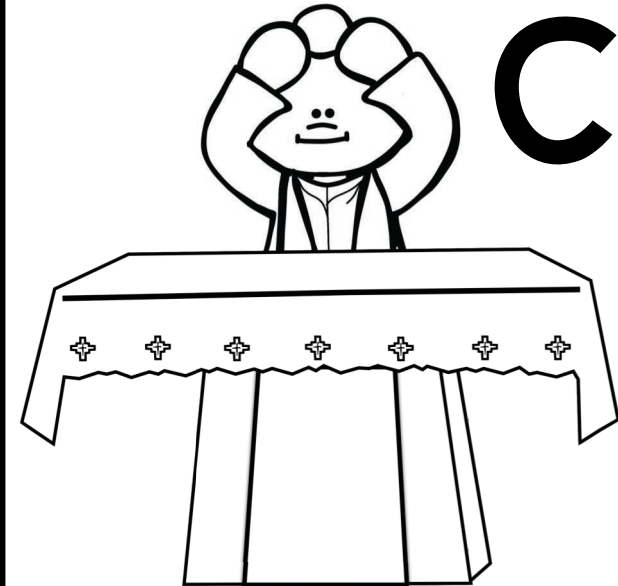

The special part of the Eucharist Prayer when the bread and wine become the Body and Blood of Jesus. This happens through the prayers and actions of the priest and the Holy Spirit.

©Adventures of a 4th Grade Classroom

CORPORAL

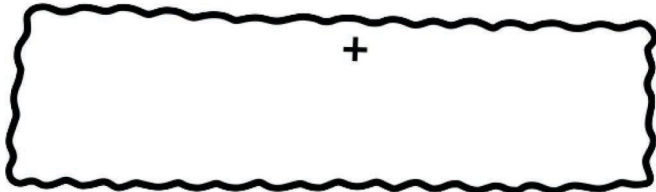

A white square cloth on the altar that the ciborium and chalice are placed on during Mass.

©Adventures of a 4th Grade Classroom



CRUET

Small containers that hold the water and wine at Mass.

©Adventures of a 4th Grade Classroom



DEACON

A man who is ordained to serve the church. They can baptize, preach, and often help the priest during Mass.

©Adventures of a 4th Grade Classroom



EUCCHARIST

One of the sacraments of initiation. During this sacrament we receive the Body and Blood of Christ. The word Eucharist means "thanksgiving".

©Adventures of a 4th Grade Classroom



GOD

God has three persons- God the Father, God the Son, and God the Holy Spirit. God is the eternal being who created and preserves all things. God has no beginning and no end.

©Adventures of a 4th Grade Classroom

HOLY COMMUNION

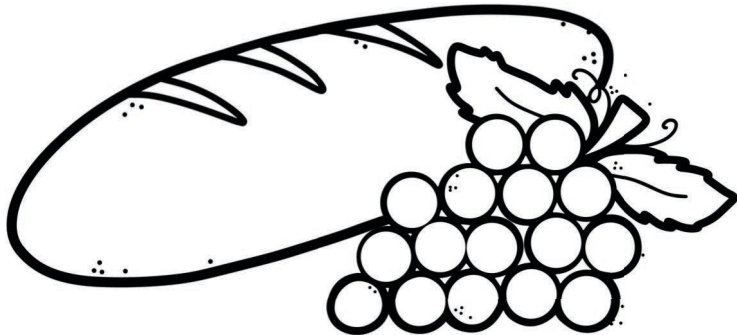

The Body and Blood of Christ that we receive in the Eucharist.

©Adventures of a 4th Grade Classroom

HOLY ORDERS

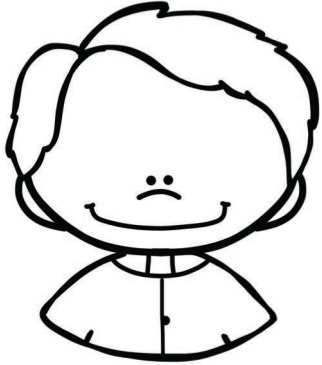

The sacrament of becoming a priest, deacon, or bishop. Once ordained, the priests, deacons, and bishops are called to serve as leaders in their local parishes and communities.

©Adventures of a 4th Grade Classroom



HOLY SPIRIT

The Holy Spirit is the third part of the Trinity—God the Holy Spirit. The Holy Spirit is often pictured as a dove or flame.

©Adventures of a 4th Grade Classroom

HOLY WATER

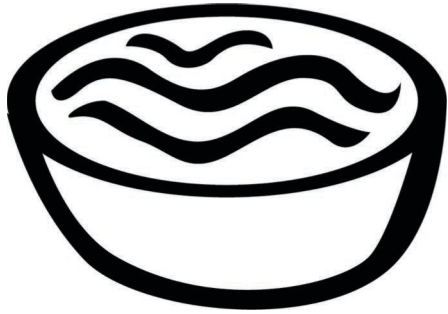

Water blessed by a priest and used in religious ceremonies. Holy water is used a baptisms, as you walk into church, and during the Easter season, just to name a few.

©Adventures of a 4th Grade Classroom

HOLY WATER FONT

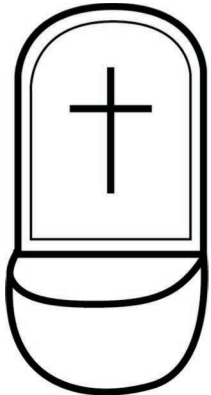

A contained of Holy Water, usually near the entrances to a church. Use this water to bless yourself with a cross as you enter and depart church.

©Adventures of a 4th Grade Classroom



HOST

A round piece of unleavened bread used at Mass. After the consecration at Mass the host becomes the Body of Christ.

©Adventures of a 4th Grade Classroom

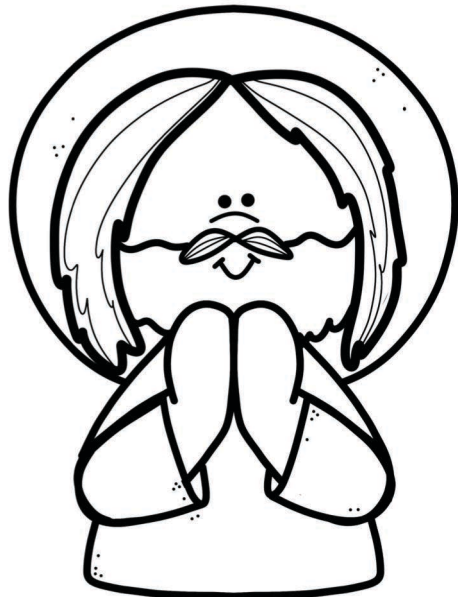

JESUS

Jesus is the second part of the Trinity- God the Son. Jesus died for our sins and so that we might one day join the Kingdom of Heaven.

©Adventures of a 4th Grade Classroom

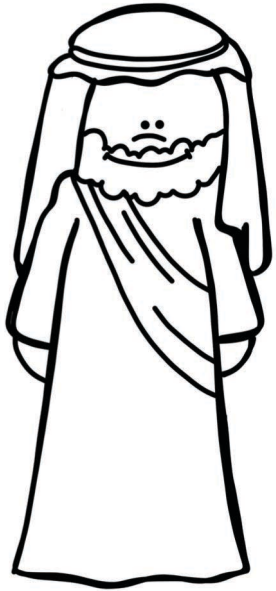

JOSEPH

Joseph was called by God to be the foster father of Jesus. He was a carpenter. Mary and Joseph raised Jesus in Nazareth where Jesus lived until he began to travel during his years of ministry.

©Adventures of a 4th Grade Classroom

KINGDOM OF GOD



The Kingdom of God, also known as the Kingdom of Heaven, is the spiritual realm over which God rules. It is not a physical place, but rather the idea that when we put God at the center of our lives, we bring about goodness in our world.

©Adventures of a 4th Grade Classroom

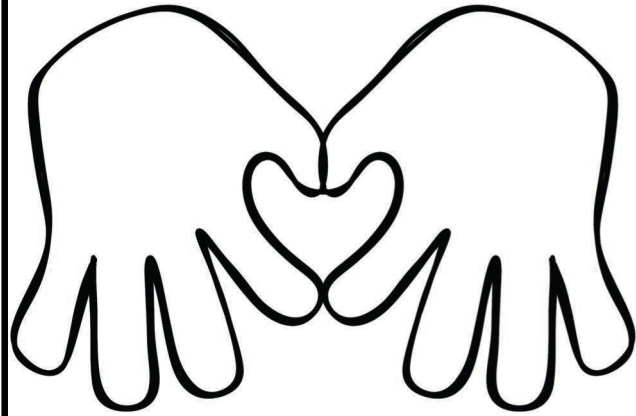

LAITY

A lay person (the laity) are non-ordained people who serve the church. An example of a lay person is someone who is a lector at mass.

©Adventures of a 4th Grade Classroom



LAST RITES

A ceremony perform by a priest when someone is nearing death. A special oil is used to bless to sick person.

©Adventures of a 4th Grade Classroom

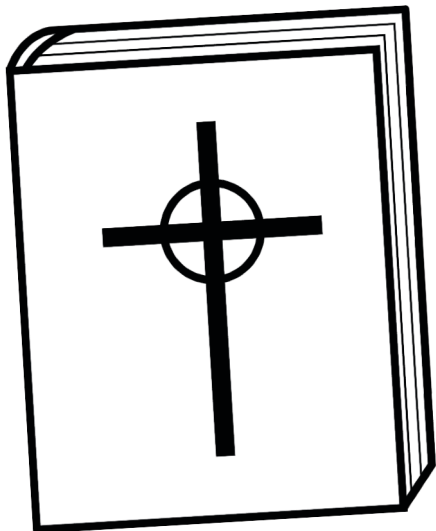

LECTOR

A person who proclaims the word of God at mass or other religious celebration. The word lector means "reader".

©Adventures of a 4th Grade Classroom



LITURGY

The general term for all the church's official acts of worship including mass, celebrations of sacraments, and Liturgy of the Hours.

©Adventures of a 4th Grade Classroom

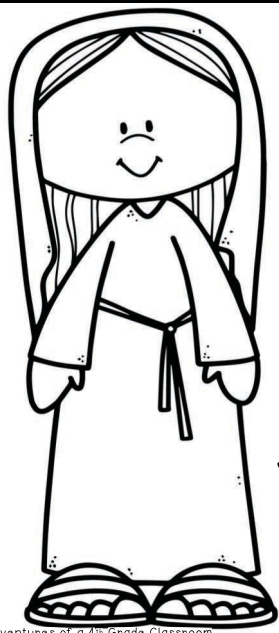

©Adventures of a 4th Grade Classroom

MARY

Mary was called by God to be the mother of Jesus. She was a humble follower of God, and grew up in a faithful Jewish family. Mary and Joseph raised Jesus in Nazareth where Jesus lived until he began to travel during his years of ministry.

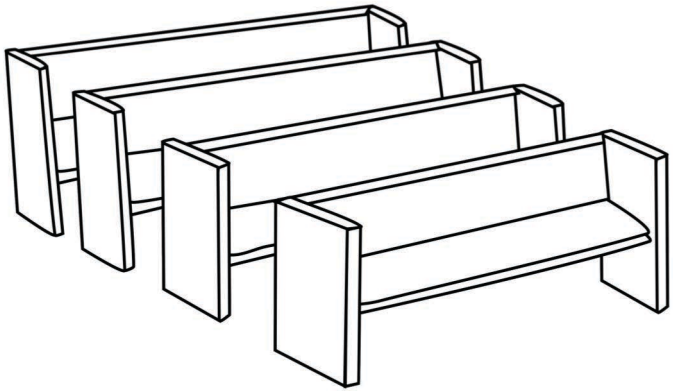

©Adventures of a 4th Grade Classroom

MASS

Another name of the celebration of the Eucharist.



MATRIMONY

Matrimony is the sacrament of marriage in the Church and is a covenant between the couple. This celebration often includes a Eucharistic liturgy.

©Adventures of a 4th Grade Classroom

NEW TESTAMENT



The new testament is the second half of the bible. It begins with the birth of Jesus and continues through Jesus' apostles going out and spreading the word of God. There are 27 books in the new testament.

©Adventures of a 4th Grade Classroom

OFFERTORY TABLE



The small table where the cruets and ciborium are placed before mass. They are usually brought to the altar after the petitions.

©Adventures of a 4th Grade Classroom

OLD TESTAMENT



The old testament is the first half of the bible. It begins with the creation story and ends with the book of Malachi. There are 46 books in the old testament.

©Adventures of a 4th Grade Classroom

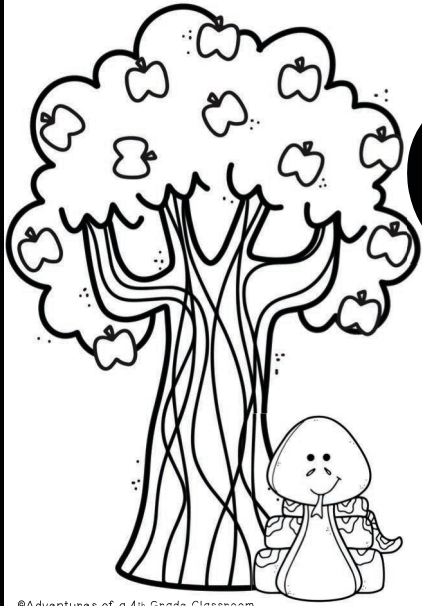

©Adventures of a 4th Grade Classroom

ORIGINAL SIN

Original Sin is the first sin committed by the first humans.

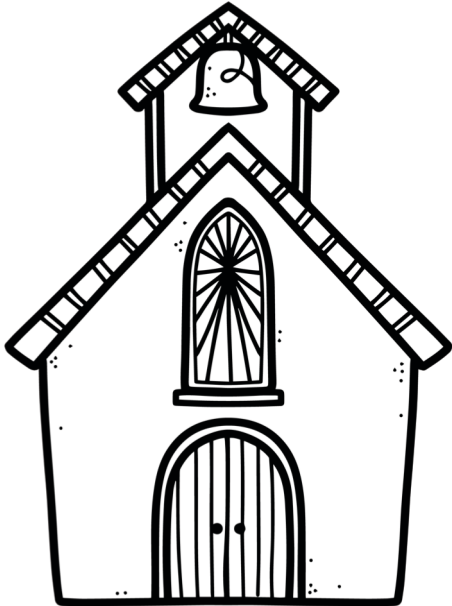

©Adventures of a 4th Grade Classroom

PARISH

A parish is a specific community of the faithful, having its own church building, and it is led by a pastor.

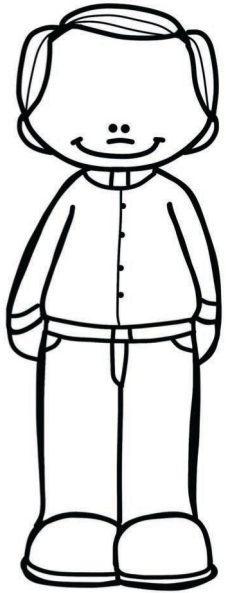

PASTOR

A pastor is a priest in charge of a parish. He is responsible for leading the community in mass, performing sacraments, and being a spiritual leader for all those in the parish.

©Adventures of a 4th Grade Classroom

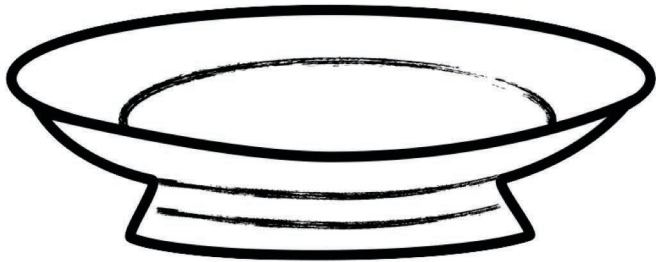

PATEN

A special gold or silver plate used at Mass to hold the large host.

©Adventures of a 4th Grade Classroom

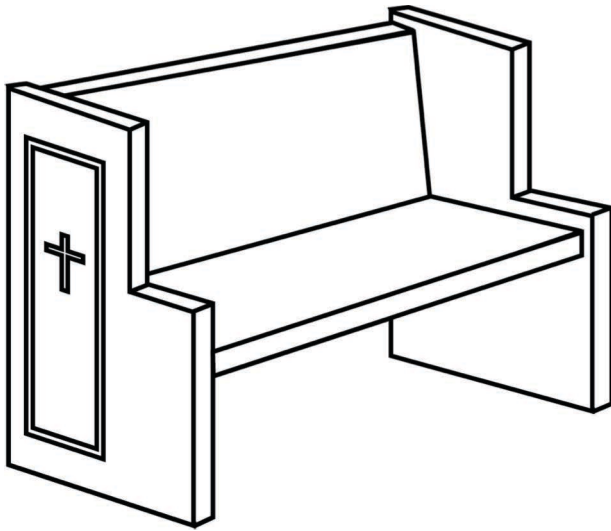

PEW

A place where mass attendees sit during mass. Often they will have a kneeler attached.



POPE

The pope is the Bishop of Rome and leader of the Catholic Church in the world. St. Peter was the first pope and today Pope Francis leads the church.

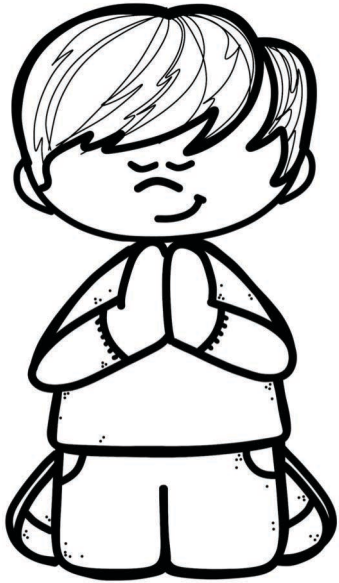

PRAYER

Prayer is talking and listening to God. Prayer can be done quietly alone, or we can pray as a community.

©Adventures of a 4th Grade Classroom

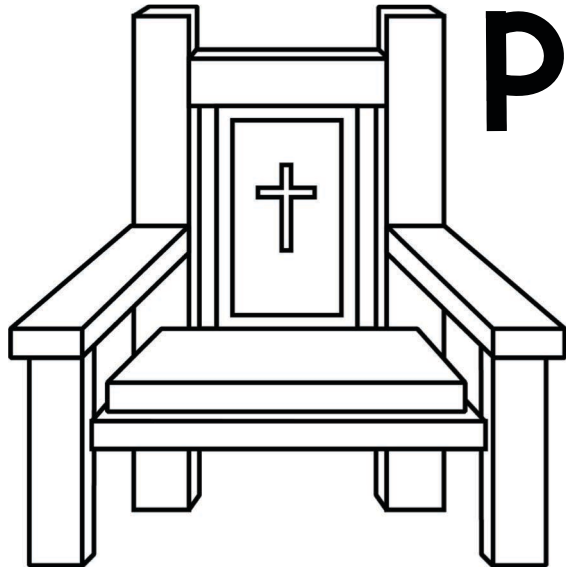

PRESIDER'S CHAIR

The place where the priest sits during Mass when the readings or being proclaimed and when he is not actively presiding over the liturgy.

©Adventures of a 4th Grade Classroom



PRIEST

A man who is ordained to serve God and the church. He can celebrate Mass, along with all other sacraments.

©Adventures of a 4th Grade Classroom

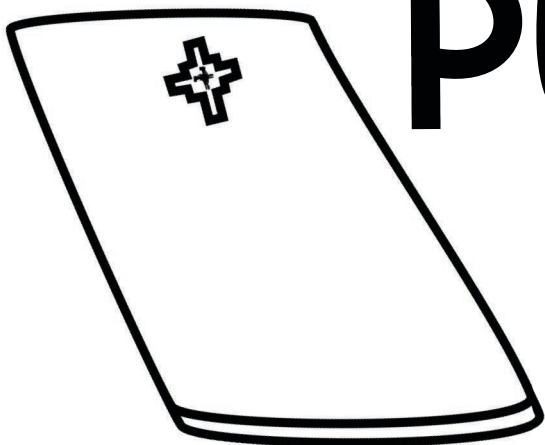

PURIFICATOR

A white cloth used to whip down the chalice after each person consumes the Blood of Christ.

©Adventures of a 4th Grade Classroom

RECONCILIATION

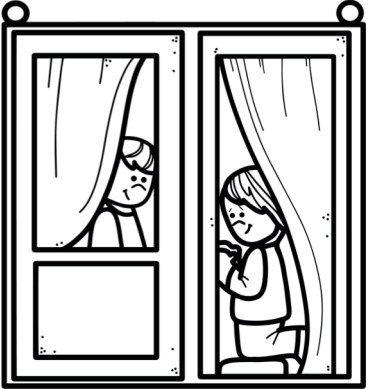

©Adventures of a 4th Grade Classroom

Reconciliation is a sacrament in which we confess our sins to God. After talking with the priest about our sins, we are absolved from them and return to full union with the Church. We often receive penance after reconciliation.

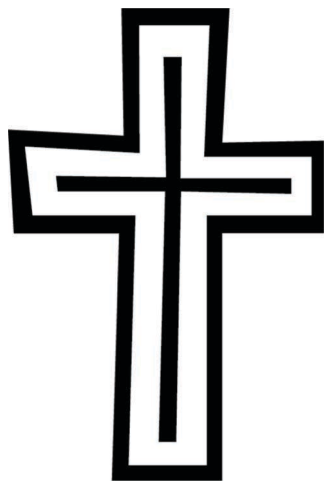

SACRAMENT

An outward sign that comes from Jesus, which gives us a share in God's life. There are seven sacraments in the Catholic Church.

©Adventures of a 4th Grade Classroom

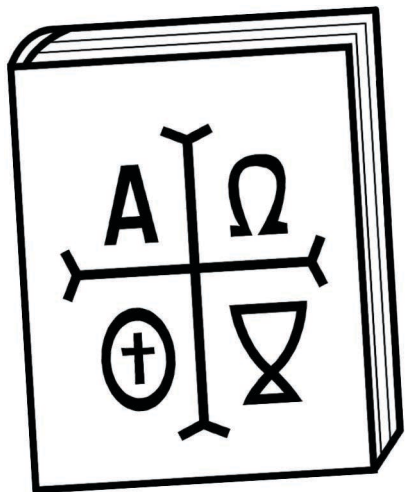

SACRAMENTARY

A book that contains all the words the priest or deacon say during mass. This includes the opening prayer, Eucharist Prayer, and closing prayer.

©Adventures of a 4th Grade Classroom



SANCTUARY

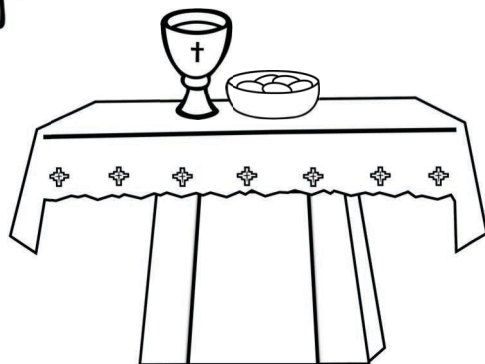

The part of the church where the altar and ambo are located.

©Adventures of a 4th Grade Classroom

SANCTUARY LAMP

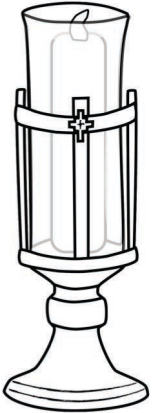

The candle, usually next to the tabernacle, that is constantly burning. This candle indicates that Jesus is present.

©Adventures of a 4th Grade Classroom

TABERNACLE

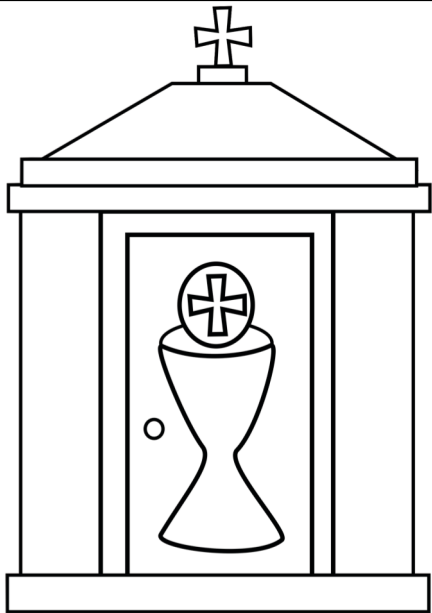

The container in which the Blessed Sacrament is kept, usually located in the sanctuary. The word tabernacle means "meeting place".

©Adventures of a 4th Grade Classroom

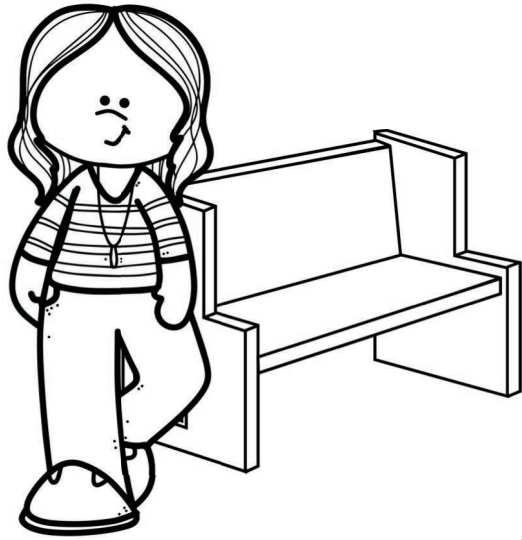

USHER

A person of hospitality who greets members of the community as they enter into church. They also help with collections and the procession to receive the Eucharist.

©Adventures of a 4th Grade Classroom



VESTMENTS

The special clothing worn by priests and deacons during mass.

©Adventures of a 4th Grade Classroom



WINE

A special drink made from grapes used at Mass. After the consecration at Mass the host becomes the Blood of Christ.

**LENT THEMED
WORDS**

ALMSGIVING



Almsgiving is when we give to those who have less than us. Part of being a Christian is serving the poor by reaching out and caring for them.

©Adventures of a 4th Grade Classroom

ASH WEDNESDAY



Ash Wednesday is the first day of Lent. Many people celebrate by attending Mass and receiving ashes on their foreheads. The ashes represent repentance and mourning.

©Adventures of a 4th Grade Classroom

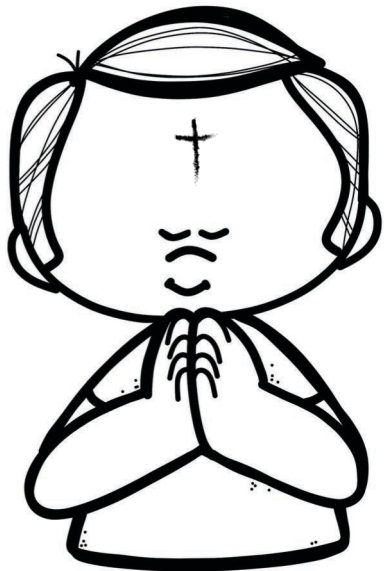

ASHES

Ashes are placed on our foreheads on the first day of Lent. The ashes are gathered from the psalms from the previous year. The ashes represent repentance and mourning.

©Adventures of a 4th Grade Classroom

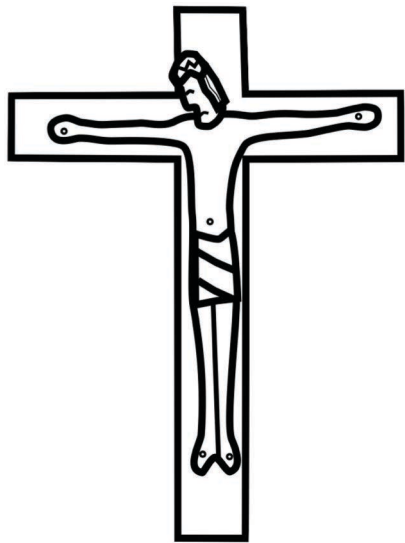

CRUCIFIX

A crucifix is a cross with a figure Jesus on it. A crucifix is a reminder that Jesus died on the cross to save us from our sins.

©Adventures of a 4th Grade Classroom



EASTER

Easter Sunday is the day Christians celebrate the resurrection of Jesus Christ. This is the holiest day of the year for most Christians.

©Adventures of a 4th Grade Classroom

FASTING

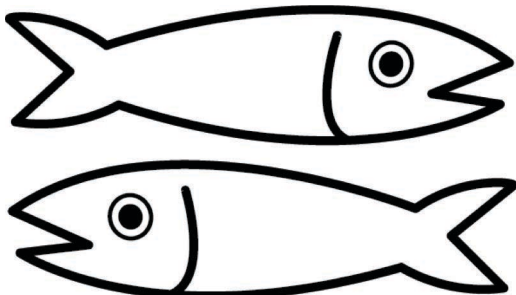

During Lent we are called to fast. Fasting should be a small sacrifice that leads us to a stronger relationship with God. Many people fast from meat on Fridays in Lent.

©Adventures of a 4th Grade Classroom

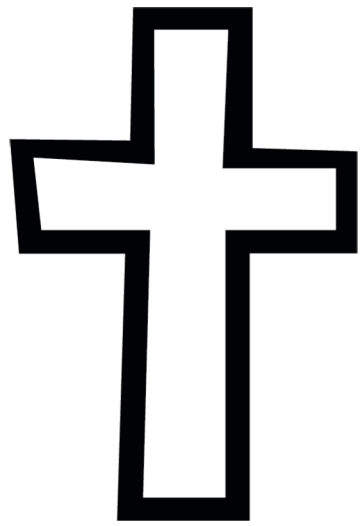

FORGIVE

When we forgive one another we let go of the hate or anger we have with someone. We also ask God to forgive our sins so that we might live fully within his kingdom.

©Adventures of a 4th Grade Classroom

GOLGOTHA

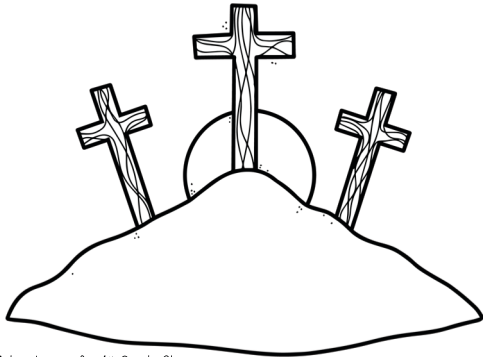

Golgotha is the hill outside of Jerusalem in which Jesus was crucified. It means "place of the skull".

©Adventures of a 4th Grade Classroom

GOOD FRIDAY

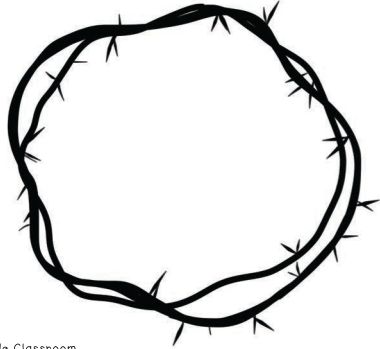

On Good Friday we remember the crucifixion and death of Jesus.

©Adventures of a 4th Grade Classroom

HOLY SATURDAY



On Holy Saturday evening the Easter Vigil is held, which is high point of the Triduum. At this mass we invite new members into the Catholic faith.

©Adventures of a 4th Grade Classroom

HOLY THURSDAY

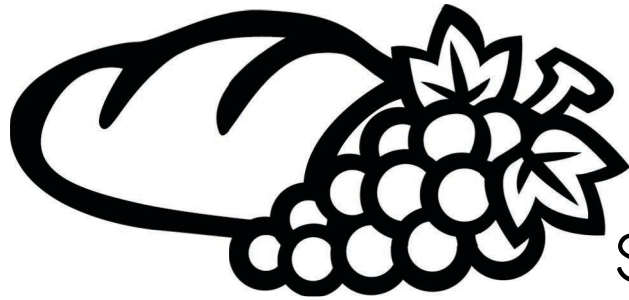

Holy Thursday evening begins the Triduum. On that day Christians remember Jesus celebrating the the Seder Passover meal with his Apostles.

©Adventures of a 4th Grade Classroom



HOLY WEEK

Holy Week begins on Palm Sunday and leads up to the Easter celebration. This is the holiest week of the year in the Catholic faith.

©Adventures of a 4th Grade Classroom

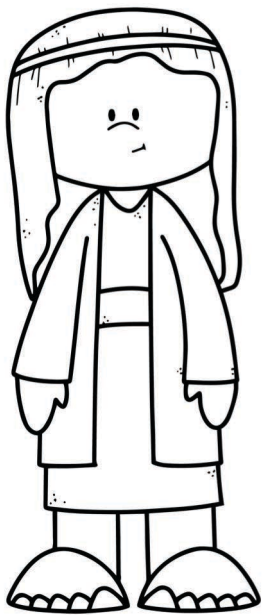

JERUSALEM

Jerusalem is the town where Jesus and his apostles celebrated Passover, which became known as the Last Supper. Jesus was crucified outside of Jerusalem at a place called Golgotha.

©Adventures of a 4th Grade Classroom

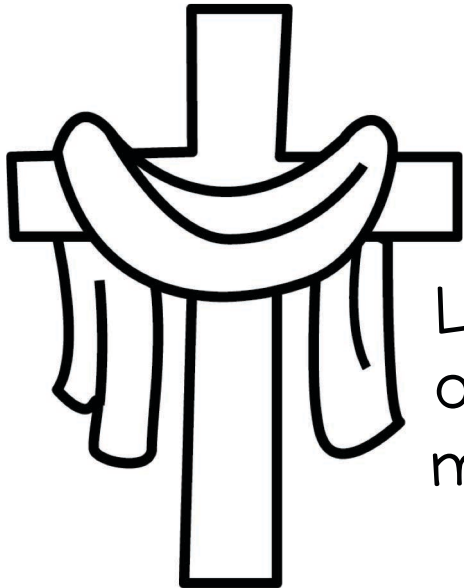

LENT

Lent is the season leading up to Easter. It begins on Ash Wednesday and ends with three holy days marking the passion, crucifixion, death, burial, and resurrection of Jesus, known as the Triduum.

©Adventures of a 4th Grade Classroom

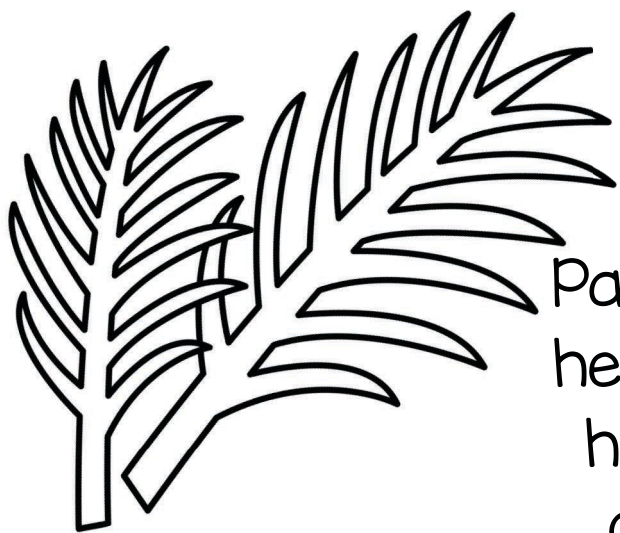

PALM

Palms were laid down by Jesus' followers as he entered into Jerusalem just days before he was crucified. We often receive a palm as we gather for mass on Palm Sunday.

©Adventures of a 4th Grade Classroom

PALM SUNDAY



Palm Sunday is the first day of Holy Week. It celebrates the day Jesus rode into the city of Jerusalem. Followers of Jesus laid down palms as he entered the city shouting, "Hosanna", which means Savior.

©Adventures of a 4th Grade Classroom

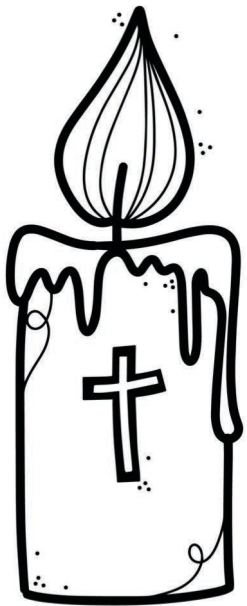

PASCHAL CANDLE

The name for the Easter candle that is lit during the Easter Vigil. Each church receives a new Paschal Candle each year and it is lit at special church celebrations.

©Adventures of a 4th Grade Classroom

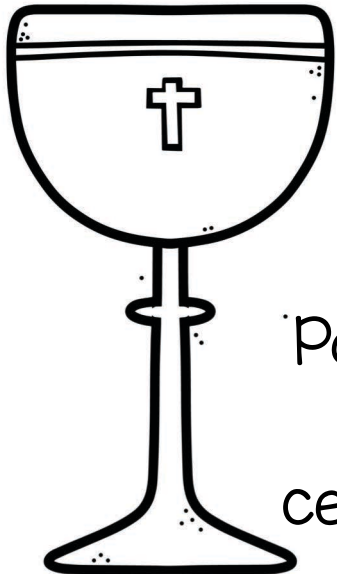

PASSOVER

Passover is a special Jewish holiday in which the Passover, or 10th plague from the book of Exodus, is remembered. Jesus and his apostles were celebrating this meal the night Jesus was betrayed by Judas.

©Adventures of a 4th Grade Classroom



PENANCE

After we confess our sins to the priest he will usually give us penance. Penance is usually a set of prayers, fasting, or being asked to give back to others. Doing penance helps us to restore our relationship with God.

©Adventures of a 4th Grade Classroom

RESURRECTION



The resurrection is when Jesus was raised from the dead three days after he was crucified. It is because of the life, death, and resurrection of Jesus that we are able to have eternal life with God.

©Adventures of a 4th Grade Classroom



SIN

Sin is any action that hurts our relationship with God and with others. Venial sin are sin that hurt our relationship with God, but does not break it. Mortal sin are sins that break our relationship with God and alienate us from the faith.

©Adventures of a 4th Grade Classroom

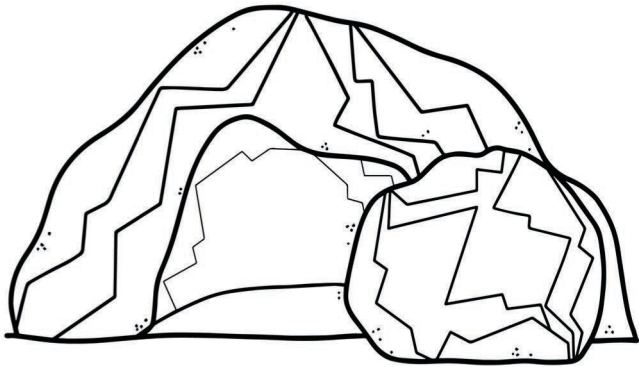

TOMB

After Jesus died on the cross, he was taken down and laid in a tomb. Jesus remained in the tomb until Easter morning when he rose from the dead.

©Adventures of a 4th Grade Classroom

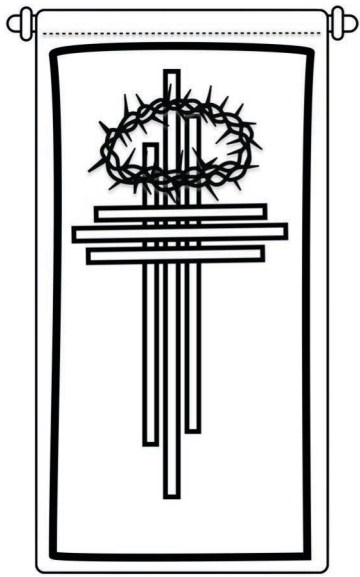

TRIDUUM

The Triduum are the three days leading up to Easter. During the Triduum we spend a lot of time at church listening to the Passion story of Christ and praying to God.

©Adventures of a 4th Grade Classroom

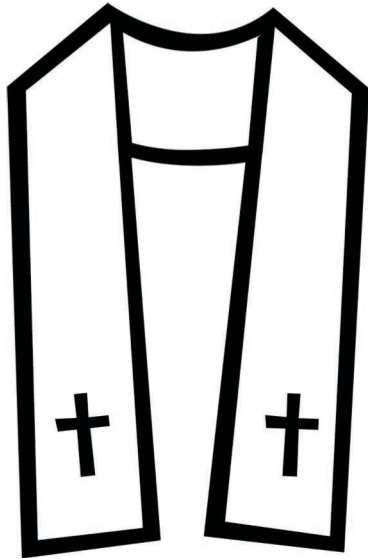

VIOLET

Violet (purple) is the color we often see in Lent. Violet is a symbol of mourning. Lent is a sorrowful time, so violet is used to represent the sadness.

©Adventures of a 4th Grade Classroom

**ADVENT
THEMED
WORDS**

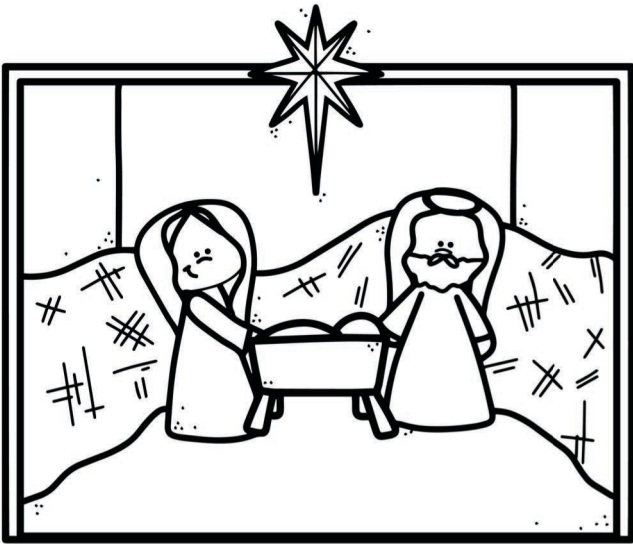

ADVENT

An angel appeared to Mary and said, "You have found favor with God. You will give birth to a son and you will name him Jesus." -Luke 1:31

©Adventures of a 4th Grade Classroom



ANGEL

An angel appeared to Mary and said, "You have found favor with God. You will give birth to a son and you will name him Jesus."
-Luke 1:31

©Adventures of a 4th Grade Classroom

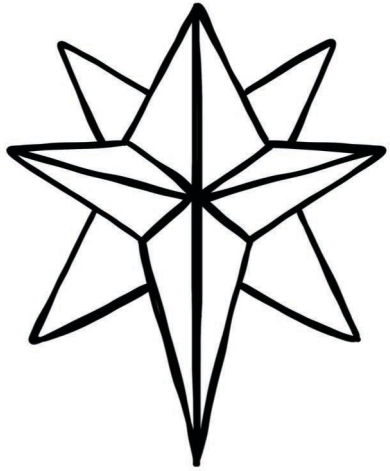

BETHLEHEM

Jesus was born in the small town of Bethlehem, the hometown of his foster father, Joseph. There are big Christmas celebrations held there each year.

©Adventures of a 4th Grade Classroom

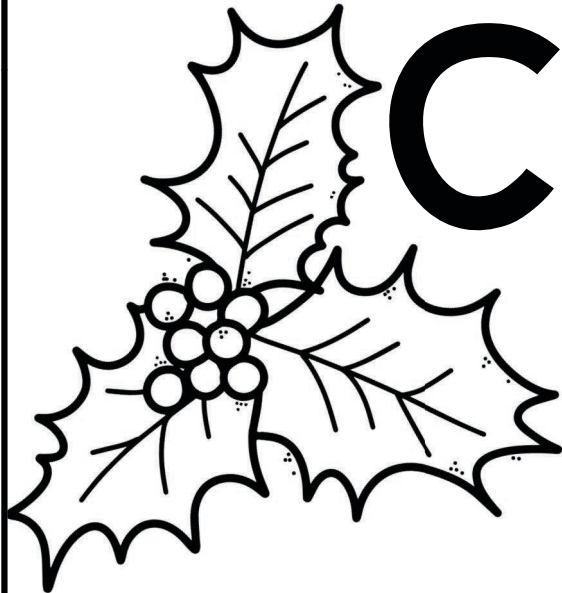

CHRISTMAS

On December 25 we celebrate Christmas, the birth of our Savior, Jesus. Christmas is a Holy Day of Obligation, so we are called to attend mass.

©Adventures of a 4th Grade Classroom

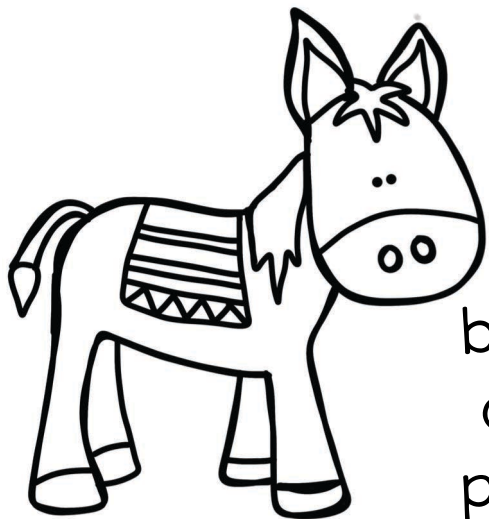

DONKEY

A donkey is part of many nativity scenes because people believe Mary rode to Bethlehem on the back of a donkey. While a donkey is not part of the biblical story of Jesus's birth, Pope Benedict said it is part of our tradition.

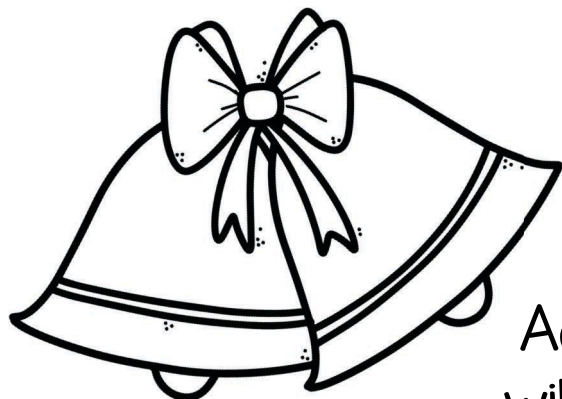

HOPE

Advent is full of hope! It is our hope that God will bring goodness to our world and will that he will come again and save us all from evil. The theme of the first week of Advent is hope.

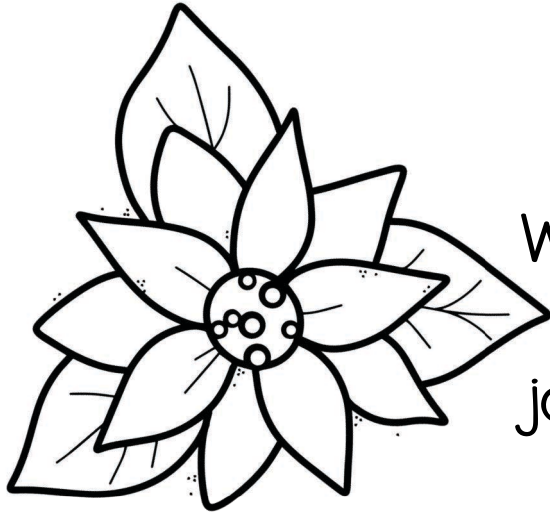

JOY

We are people of joy during Advent because we know that God loves us. We share our joy with others and show them the light of Christ during Advent. The theme of the third week of Advent is joy.

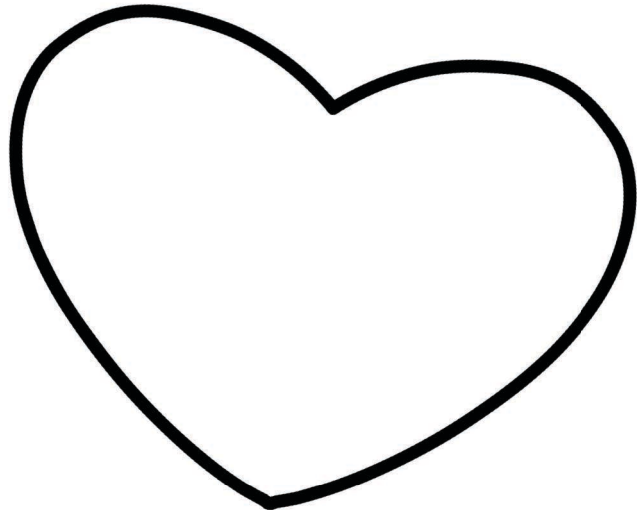

LOVE

We are called to love others- our family, friends, neighbors, and even our enemies. The theme of the fourth week of Advent is love.

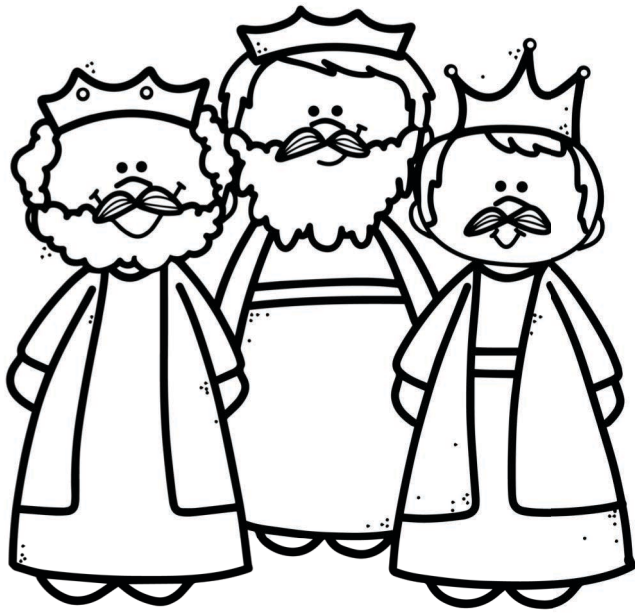

©Adventures of a 4th Grade Classroom

MAGI

Three Magi visited baby Jesus in Bethlehem. They offered him gifts of gold, frankincense, and myrrh.

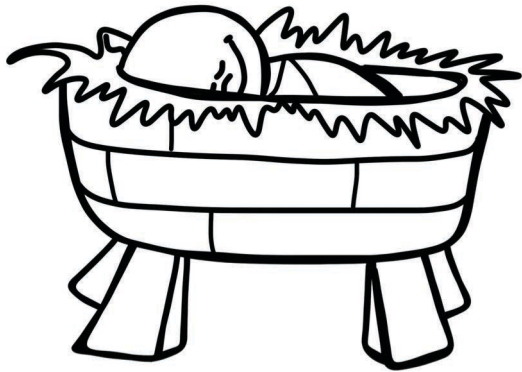

©Adventures of a 4th Grade Classroom

MANGER

After Jesus was born, his mother, Mary, placed him in a manger. A manger is a box in which animals, such as donkeys and horses, eat hay out of.

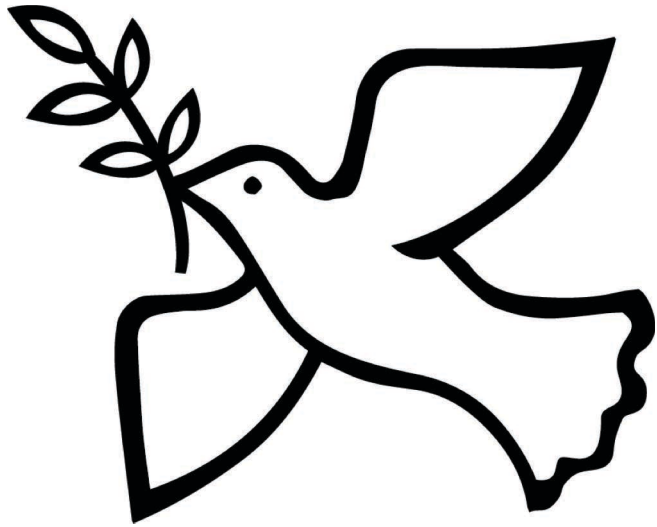

PEACE

The birth of Christ has brought about peace. The theme of the second week of Advent is peace.

©Adventures of a 4th Grade Classroom



PINK

The third candle we light on the Advent wreath is pink. Pink is the color joy. On this Sunday celebrate that Christmas is coming very soon!

©Adventures of a 4th Grade Classroom

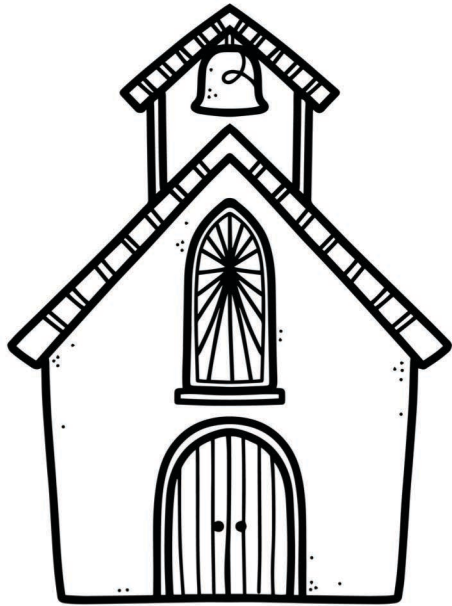

©Adventures of a 4th Grade Classroom

PREPARE

Advent is a time when we prepare our hearts for the coming of Jesus on Christmas. We light one candle of the Advent wreath each week to show that we are getting closer to the birth of Jesus.

PURPLE

The first, second, and fourth candles we light on the Advent wreath are purple.

Purple is the color of royalty and penance. It reminds us that Jesus is coming as the Prince of Peace, our King.

©Adventures of a 4th Grade Classroom



SHEPHERDS

Shepherds were out in the fields when an angel appeared to them. They were scared, but the angel said, "Do not be afraid.

I bring you good news of great joy that will be for all the people. Today in the town of David, a Savior has been born to you; he is Christ the Lord." The shepherds then followed the bright night star to find baby Jesus.

©Adventures of a 4th Grade Classroom

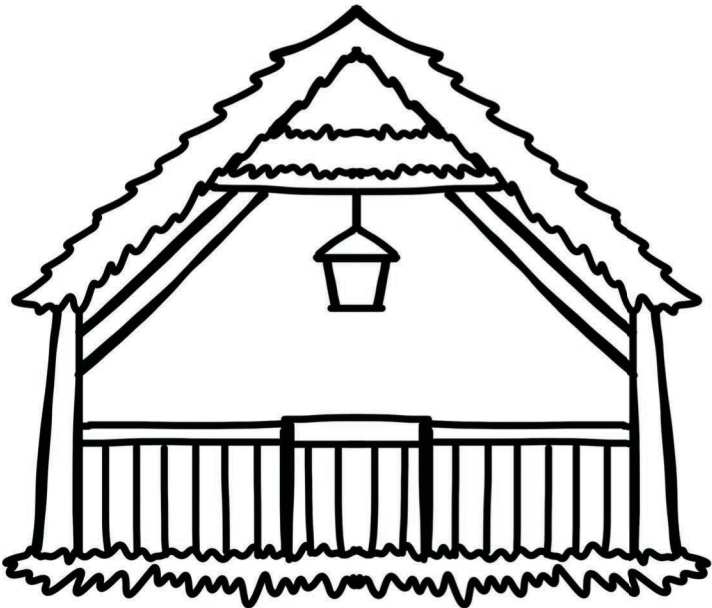

STABLE

Mary gave birth to baby Jesus in a stable in Bethlehem. A stable is a place where people keep animals.

©Adventures of a 4th Grade Classroom

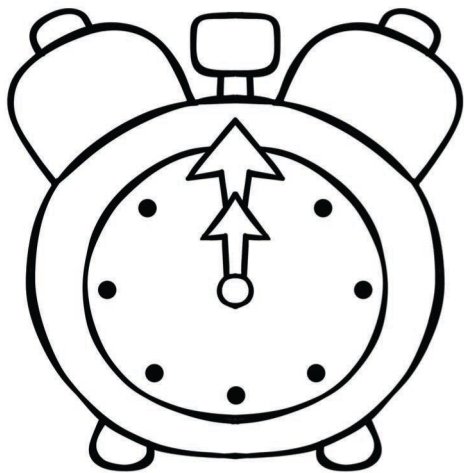

WAIT

Advent is a time of waiting. We are awaiting the coming of our Savior, Jesus Christ. We must practice patience during Advent while we wait for Christmas morning to arrive.

©Adventures of a 4th Grade Classroom

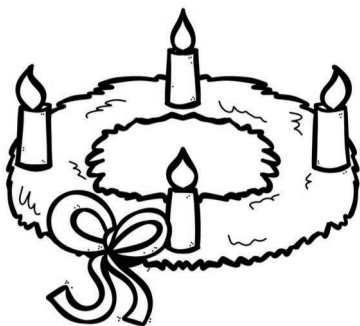

WREATH

Many people put Advent wreaths out during the weeks before Christmas. The wreath is round and represents the unending love of God. Each week we light another candle on the wreath to show we are getting closer to the birth of Jesus.

©Adventures of a 4th Grade Classroom

**GENERAL
CATHOLIC
WORDS
PRIMARY
GRADES**

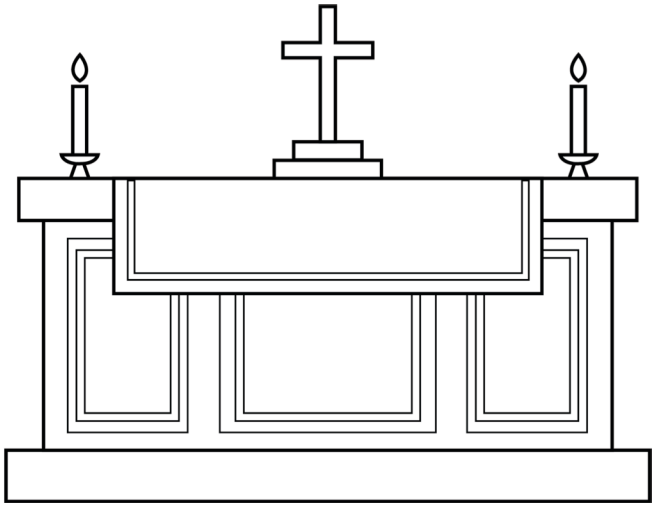

ALTAR

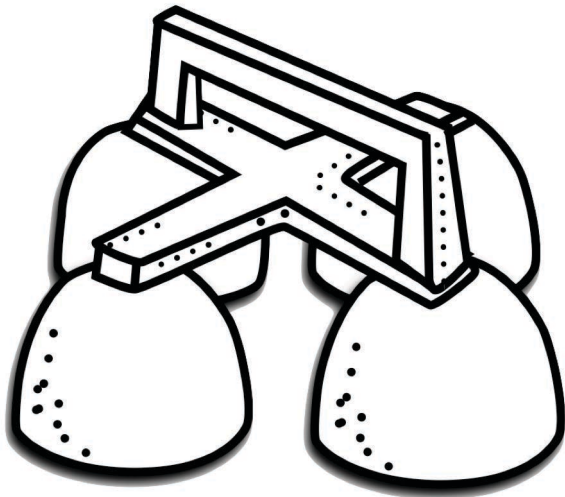

**ALTAR
BELLS**

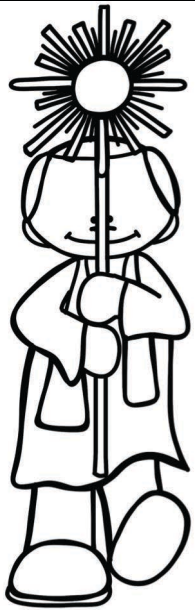

ALTAR SERVER

©Adventures of a 4th Grade Classroom

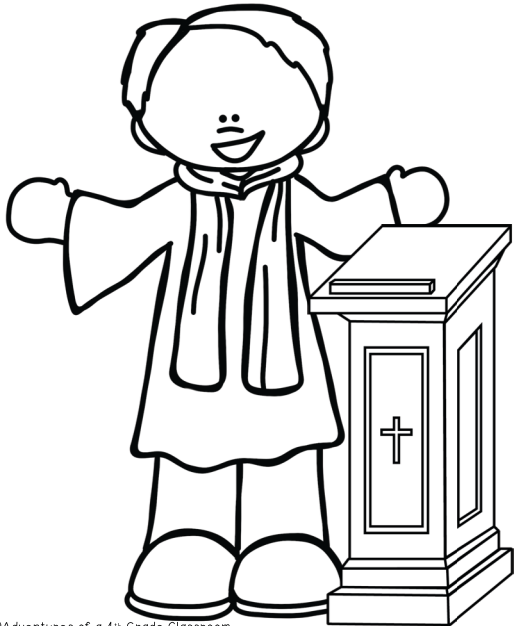

AMBO

©Adventures of a 4th Grade Classroom



APOSTLE

©Adventures of a 4th Grade Classroom



BAPTISM

©Adventures of a 4th Grade Classroom

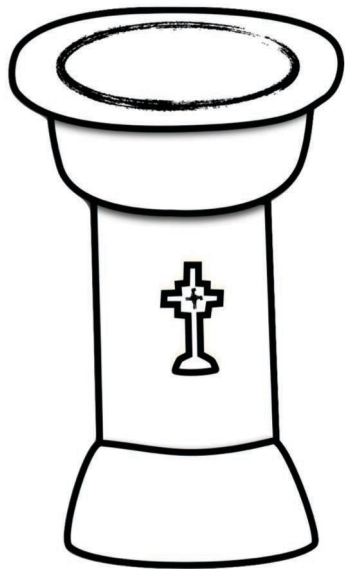

BAPTISMAL FONT

©Adventures of a 4th Grade Classroom

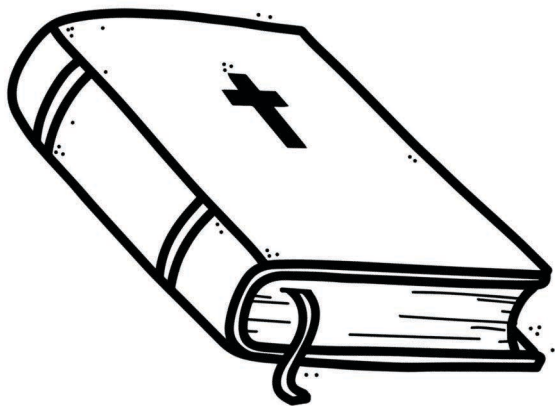

BIBLE

©Adventures of a 4th Grade Classroom

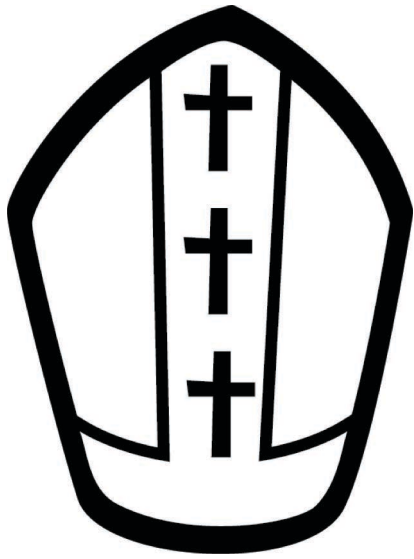

BISHOP

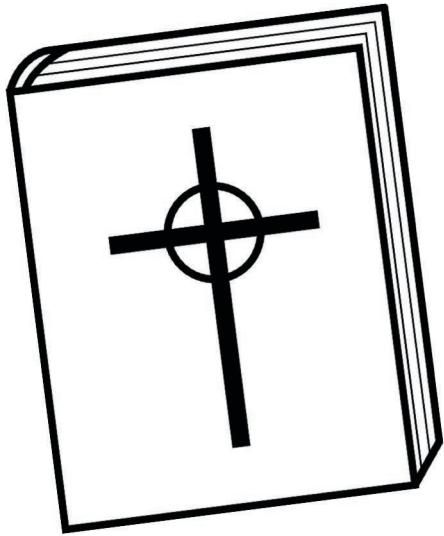

**BOOK OF
GOSPELS**

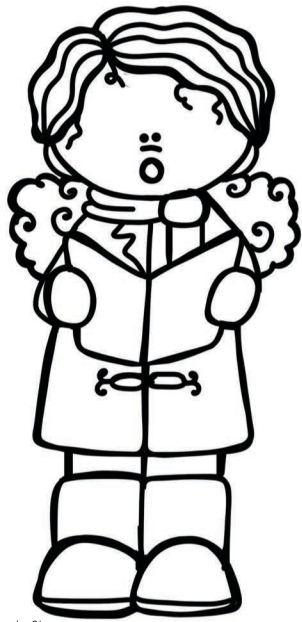

CANTOR

©Adventures of a 4th Grade Classroom

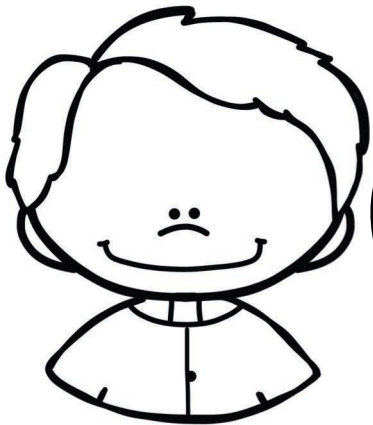

CARDINAL

©Adventures of a 4th Grade Classroom

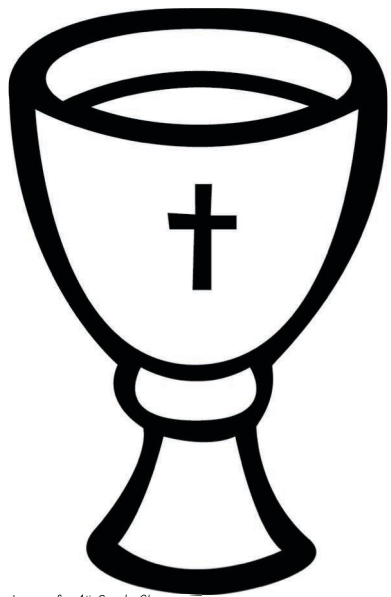

CHALICE

©Adventures of a 4th Grade Classroom

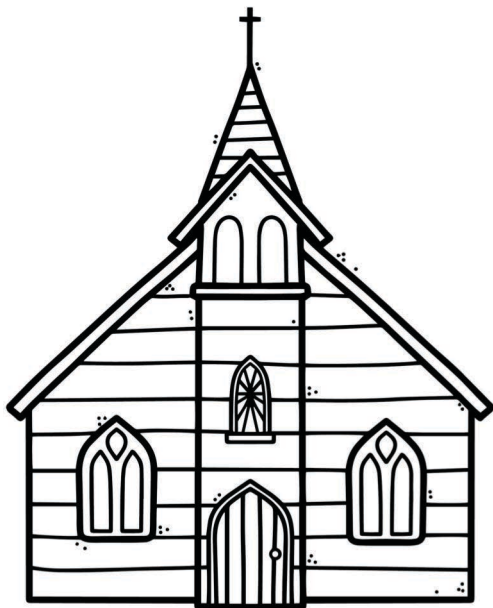

CHURCH

©Adventures of a 4th Grade Classroom



CIBORIUM

©Adventures of a 4th Grade Classroom

CONCLAVE



©Adventures of a 4th Grade Classroom

CONFIRMATION

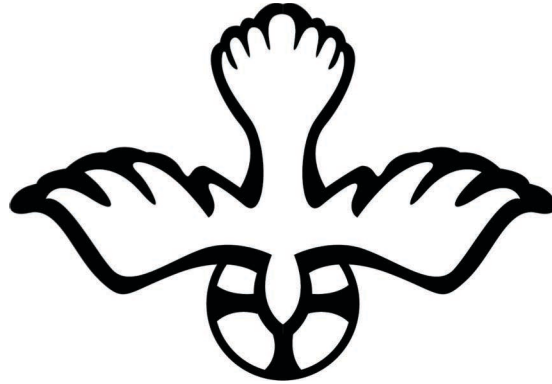

©Adventures of a 4th Grade Classroom

CONSECRATION

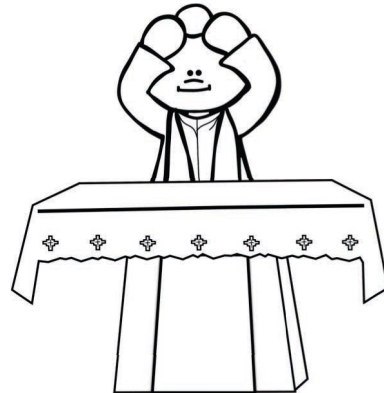

©Adventures of a 4th Grade Classroom

CORPORAL

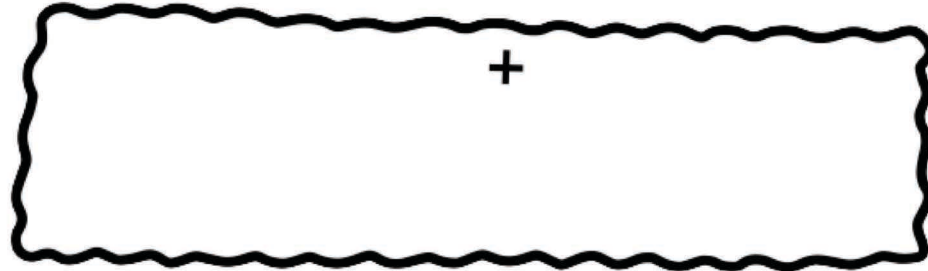

©Adventures of a 4th Grade Classroom



CRUET

©Adventures of a 4th Grade Classroom



DEACON

©Adventures of a 4th Grade Classroom



EUCHARIST

©Adventures of a 4th Grade Classroom



GOD

©Adventures of a 4th Grade Classroom

HOLY COMMUNION

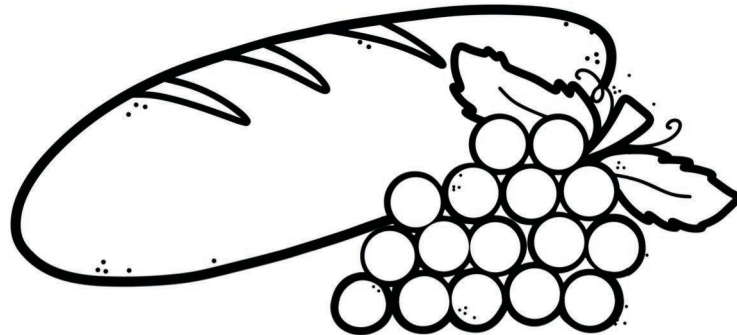

©Adventures of a 4th Grade Classroom

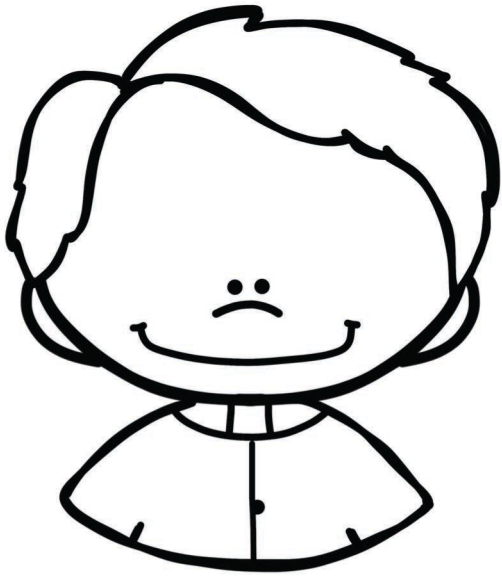

**HOLY
ORDERS**

©Adventures of a 4th Grade Classroom



**HOLY
SPIRIT**

©Adventures of a 4th Grade Classroom

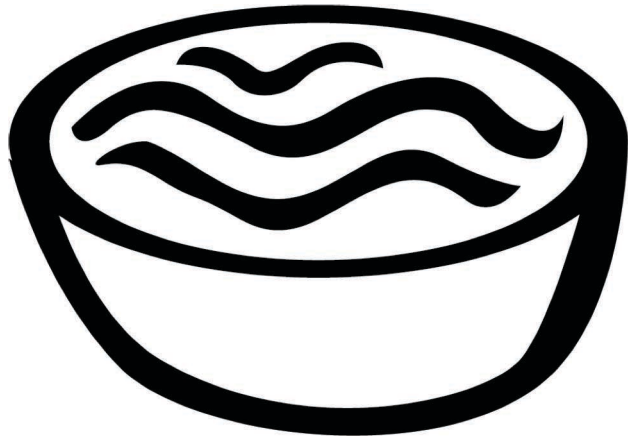

**HOLY
WATER**

©Adventures of a 4th Grade Classroom

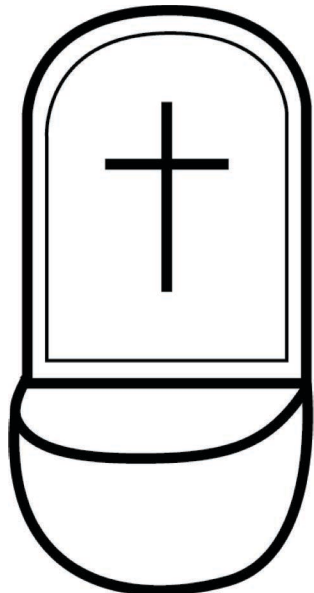

**HOLY WATER
FONT**

©Adventures of a 4th Grade Classroom



HOST

©Adventures of a 4th Grade Classroom

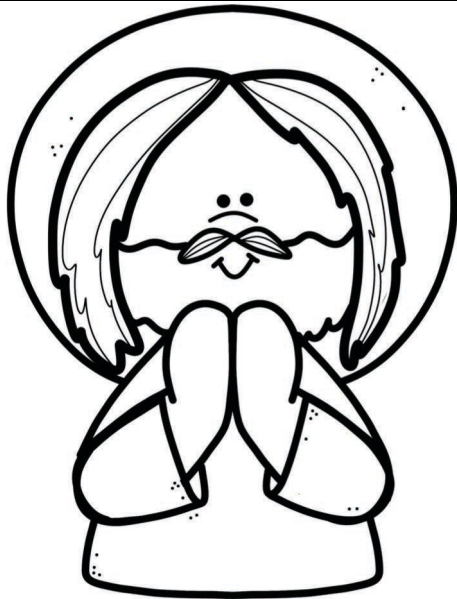

JESUS

©Adventures of a 4th Grade Classroom

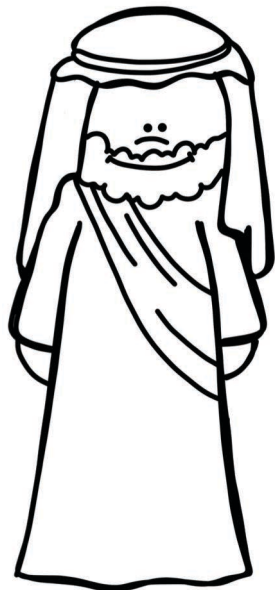

JOSEPH

©Adventures of a 4th Grade Classroom



**KINGDOM
OF GOD**

©Adventures of a 4th Grade Classroom

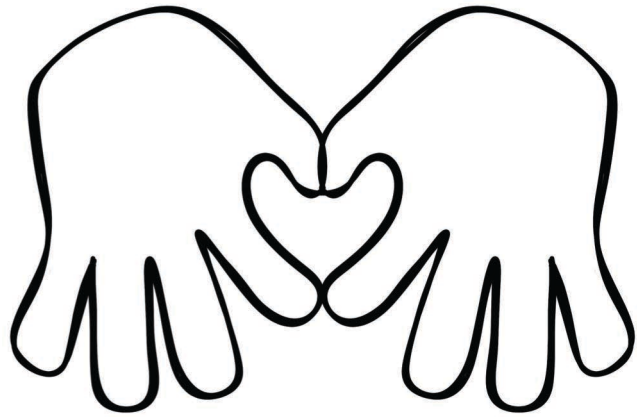

LAITY



**LAST
RITES**

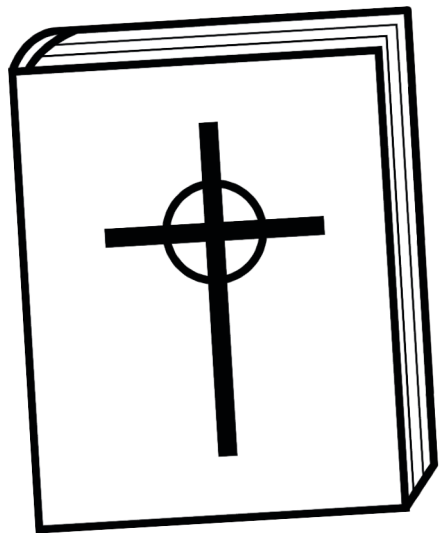

LECTOR

©Adventures of a 4th Grade Classroom



LITURGY

©Adventures of a 4th Grade Classroom

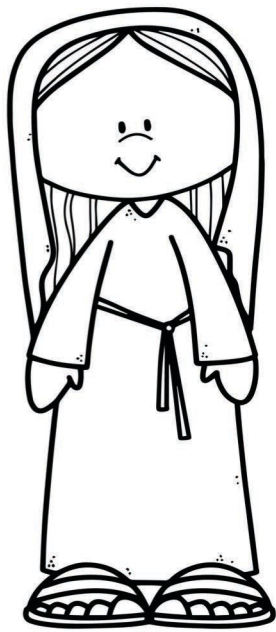

MARY

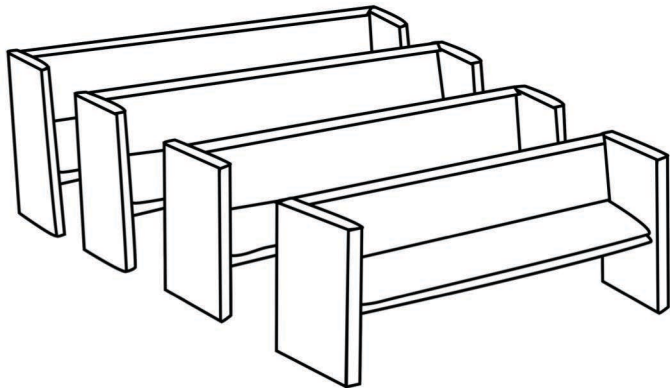

MASS



MATRIMONY

©Adventures of a 4th Grade Classroom

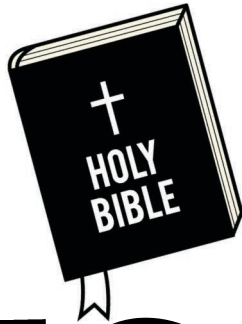

NEW TESTAMENT

©Adventures of a 4th Grade Classroom

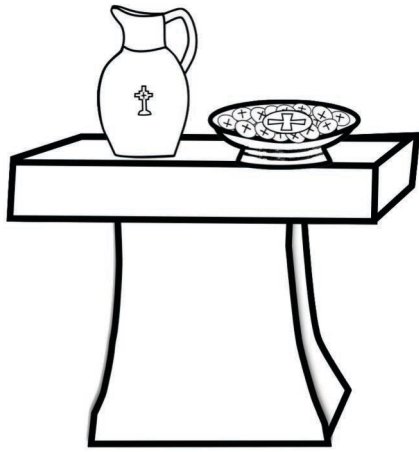

OFFERTORY TABLE

©Adventures of a 4th Grade Classroom

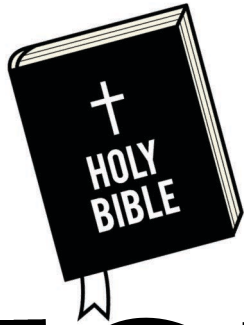

OLD TESTAMENT

©Adventures of a 4th Grade Classroom

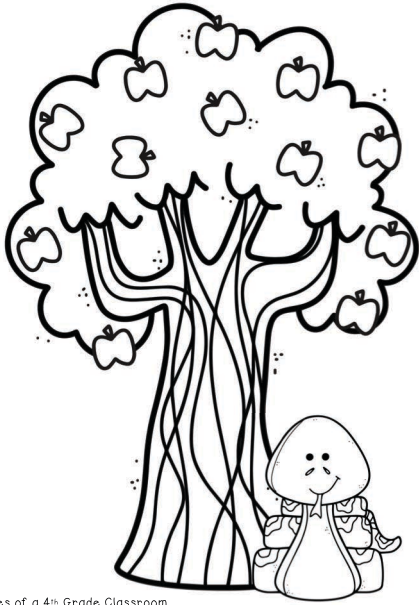

**ORIGINAL
SIN**

©Adventures of a 4th Grade Classroom

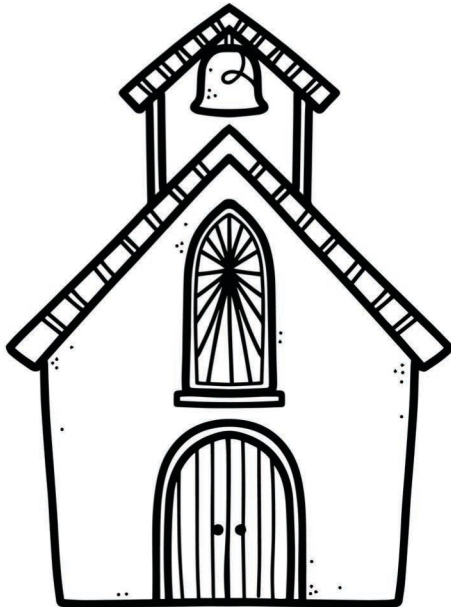

PARISH

©Adventures of a 4th Grade Classroom

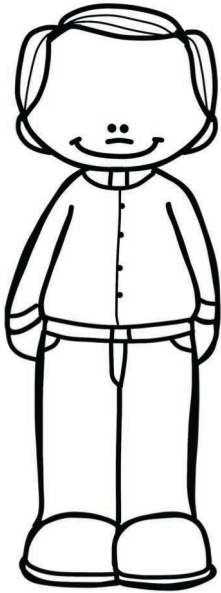

PASTOR

PATEN



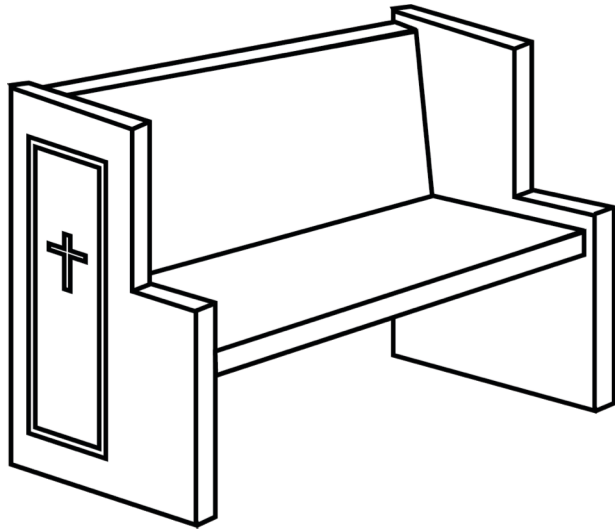

PEW



POPE



PRAYER

©Adventures of a 4th Grade Classroom

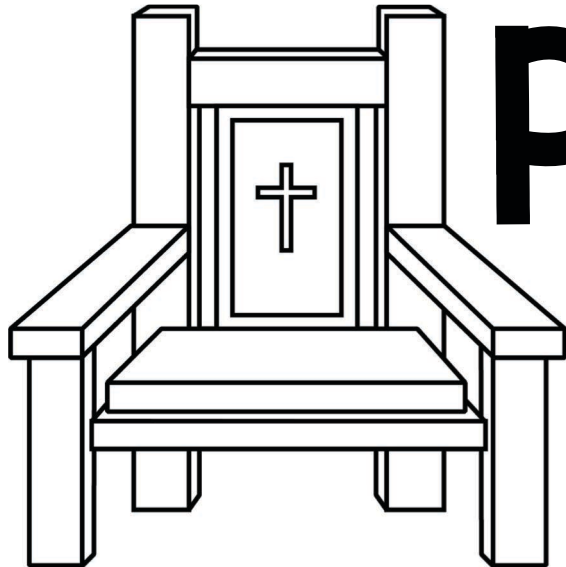

PRESIDER'S CHAIR

©Adventures of a 4th Grade Classroom



PRIEST

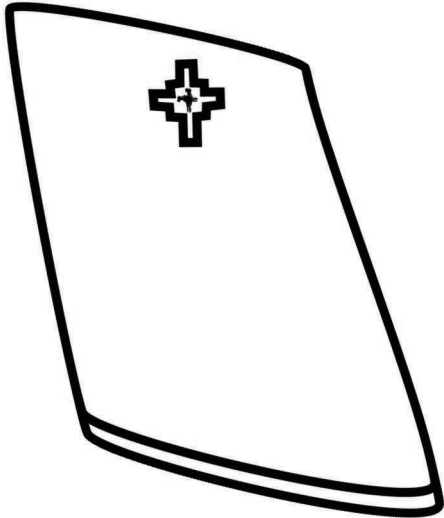

PURIFICATOR

RECONCILIATION



©Adventures of a 4th Grade Classroom

✝ SACRAMENT

©Adventures of a 4th Grade Classroom

SACRAMENTARY

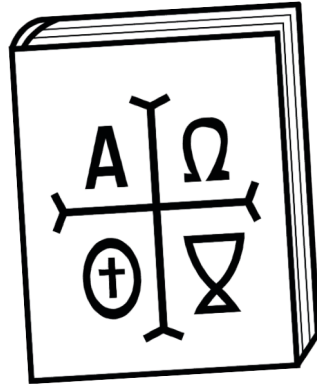

©Adventures of a 4th Grade Classroom

SANCTUARY

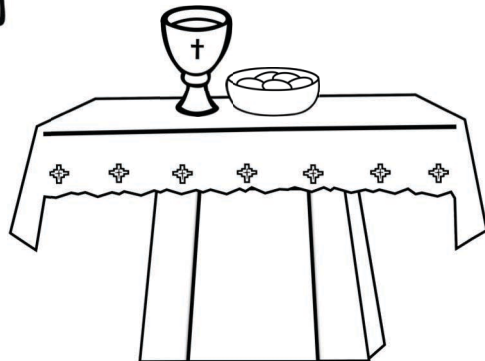

©Adventures of a 4th Grade Classroom

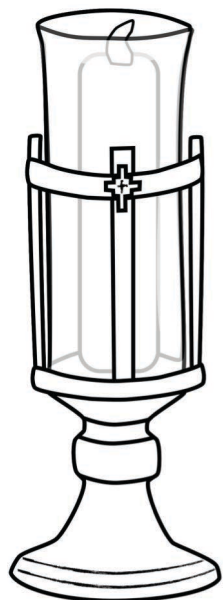

SANCTUARY LAMP

©Adventures of a 4th Grade Classroom

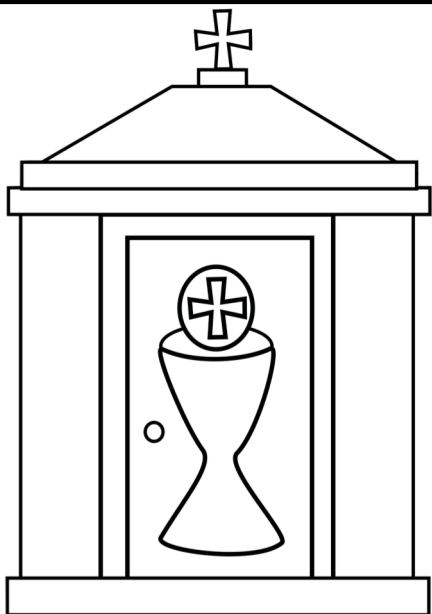

TABERNACLE

©Adventures of a 4th Grade Classroom

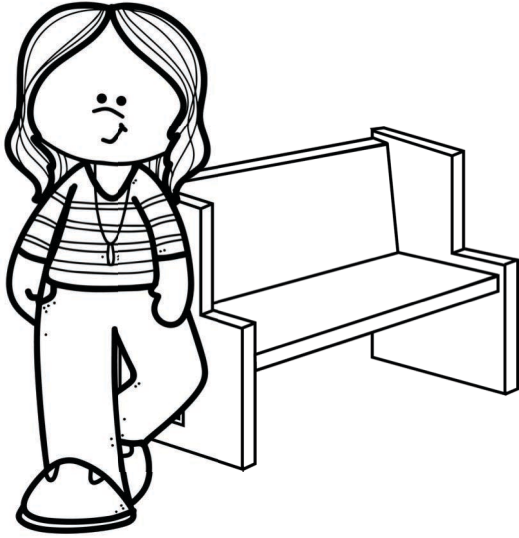

USHER

©Adventures of a 4th Grade Classroom



VESTMENTS

©Adventures of a 4th Grade Classroom



WINE

LENT THEMED

WORDS

PRIMARY

GRADES

ALMSGIVING



©Adventures of a 4th Grade Classroom



ASH WEDNESDAY

©Adventures of a 4th Grade Classroom

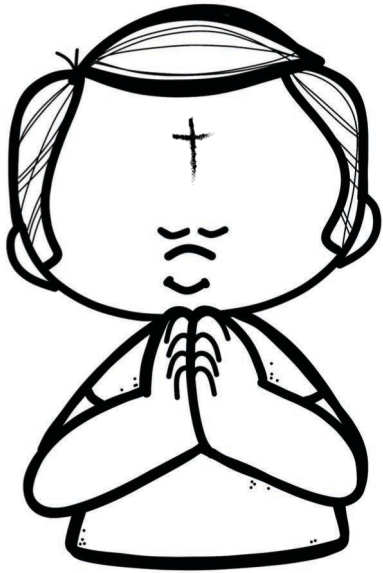

ASHES

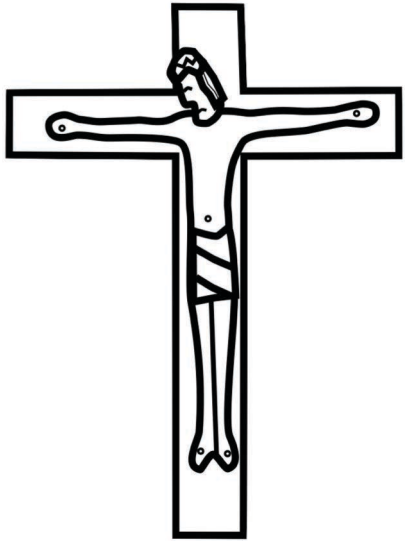

CRUCIFIX



EASTER

©Adventures of a 4th Grade Classroom

FASTING

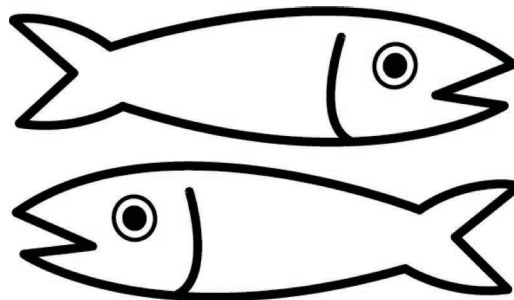

©Adventures of a 4th Grade Classroom

+ **FORGIVE**

©Adventures of a 4th Grade Classroom

GOLGOTHA

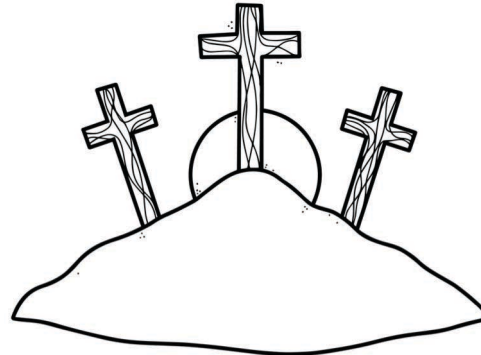

©Adventures of a 4th Grade Classroom

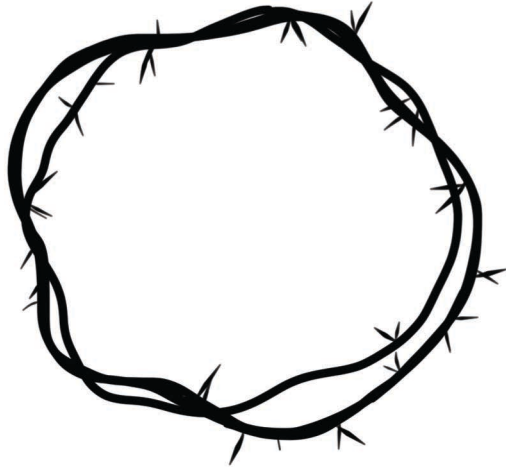

**GOOD
FRIDAY**

©Adventures of a 4th Grade Classroom

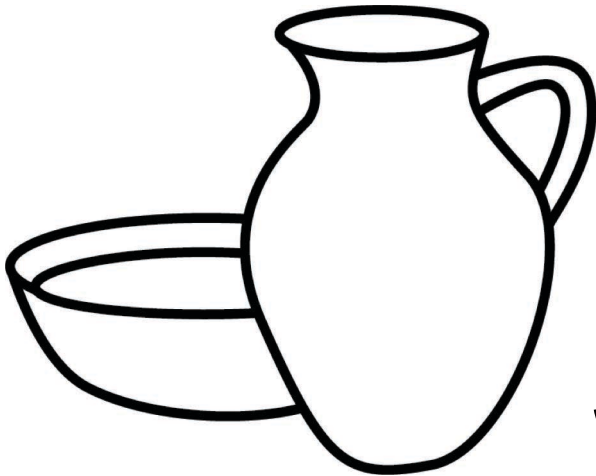

**HOLY
SATURDAY**

©Adventures of a 4th Grade Classroom

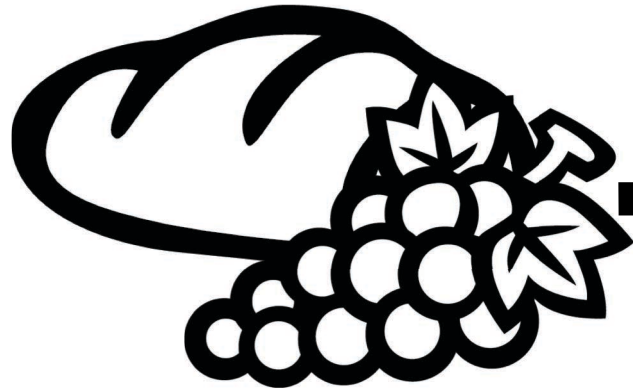

**HOLY
THURSDAY**

©Adventures of a 4th Grade Classroom



**HOLY
WEEK**

©Adventures of a 4th Grade Classroom

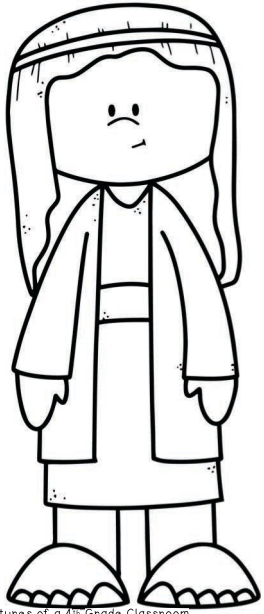

JERUSALEM

©Adventures of a 4th Grade Classroom

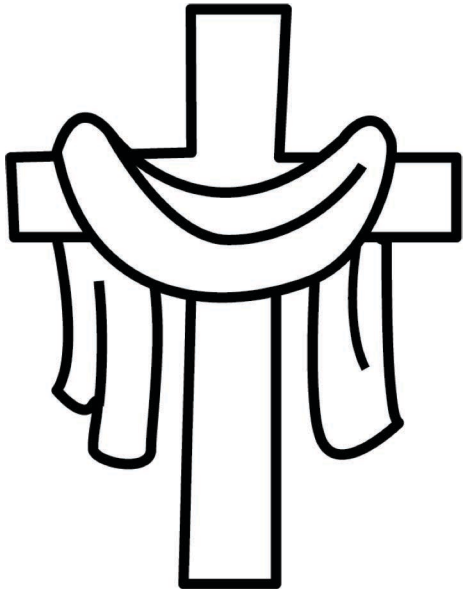

LENT

©Adventures of a 4th Grade Classroom

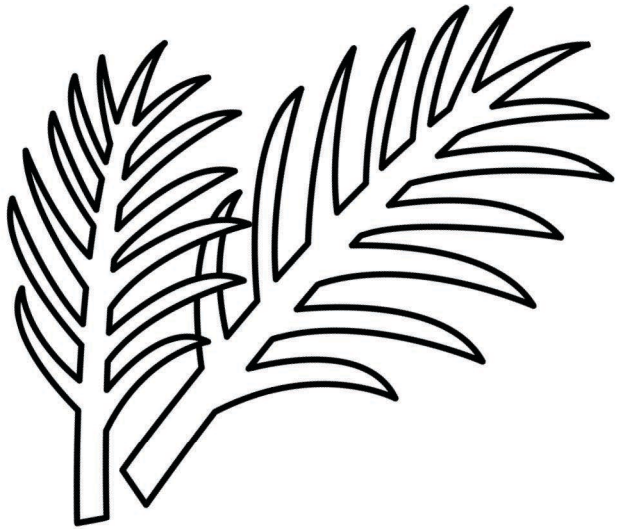

PALM

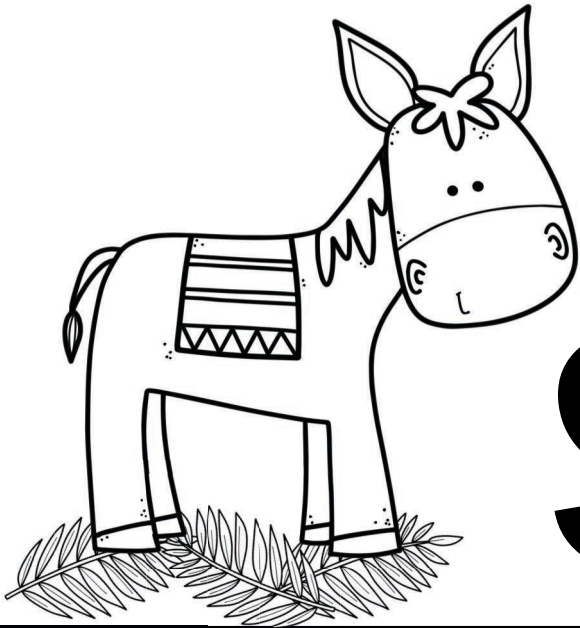

**PALM
SUNDAY**

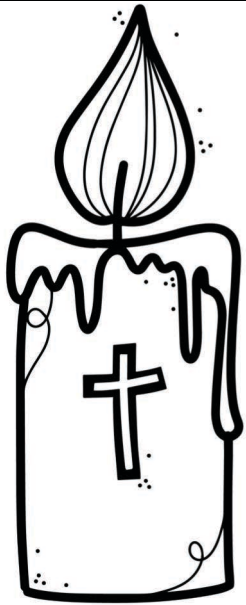

**PASCHAL
CANDLE**

©Adventures of a 4th Grade Classroom

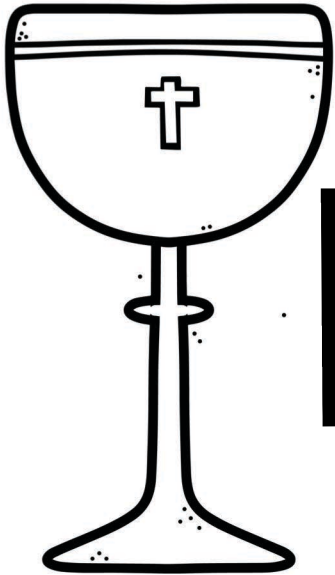

PASSOVER

©Adventures of a 4th Grade Classroom



PENANCE

©Adventures of a 4th Grade Classroom

RESURRECTION



©Adventures of a 4th Grade Classroom



SIN

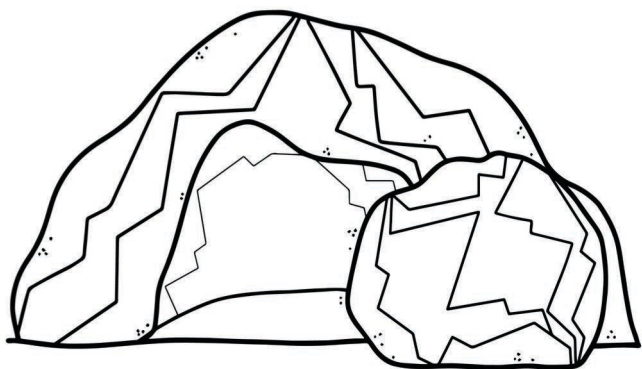

TOMB

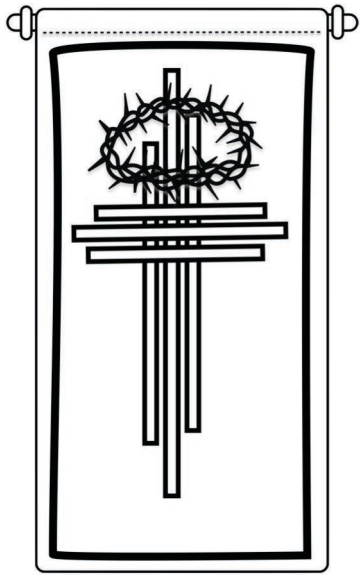

TRIDUUM

©Adventures of a 4th Grade Classroom

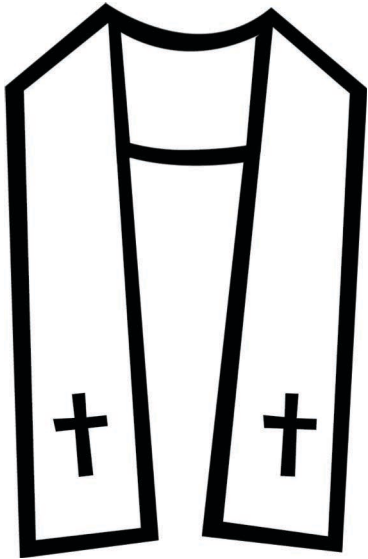

VIOLET

©Adventures of a 4th Grade Classroom

**ADVENT
THEMED WORDS
PRIMARY
GRADES**

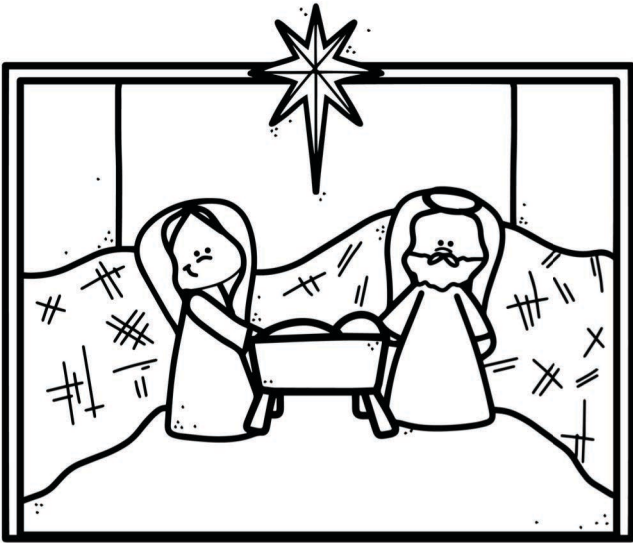

ADVENT

©Adventures of a 4th Grade Classroom



ANGEL

©Adventures of a 4th Grade Classroom

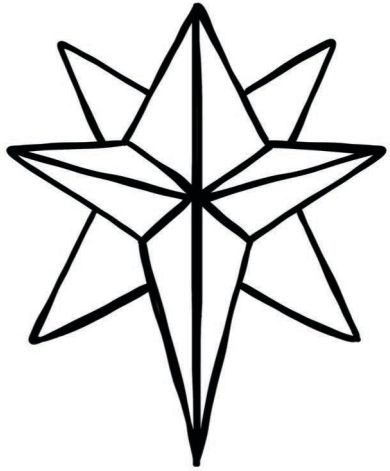

BETHLEHEM



CHRISTMAS

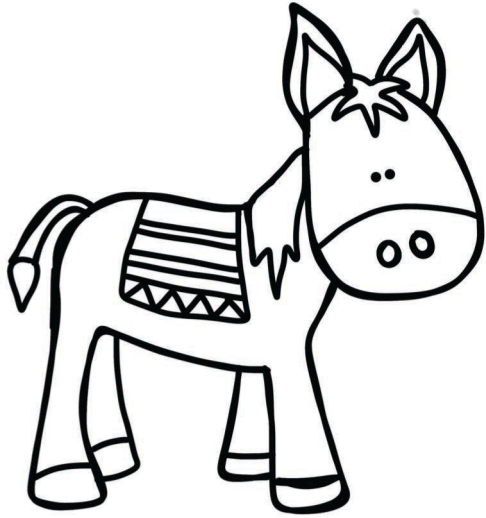

DONKEY

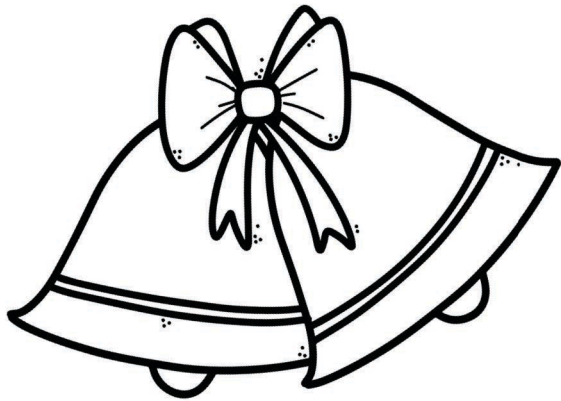

HOPE

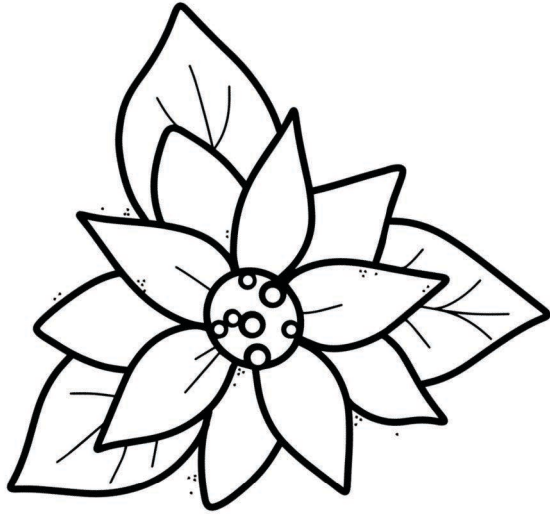

JOY

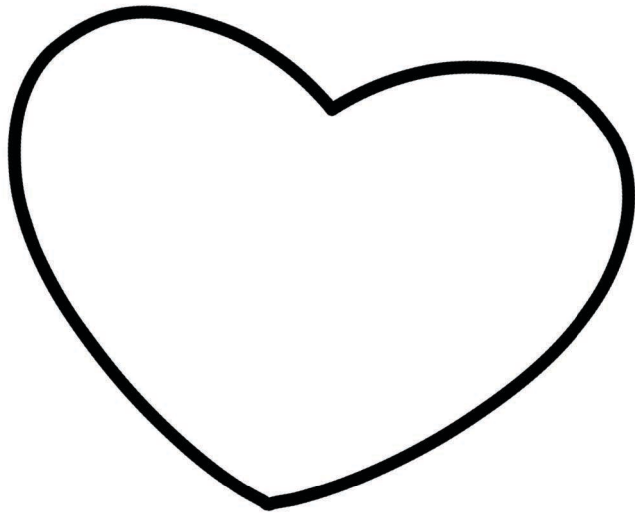

LOVE

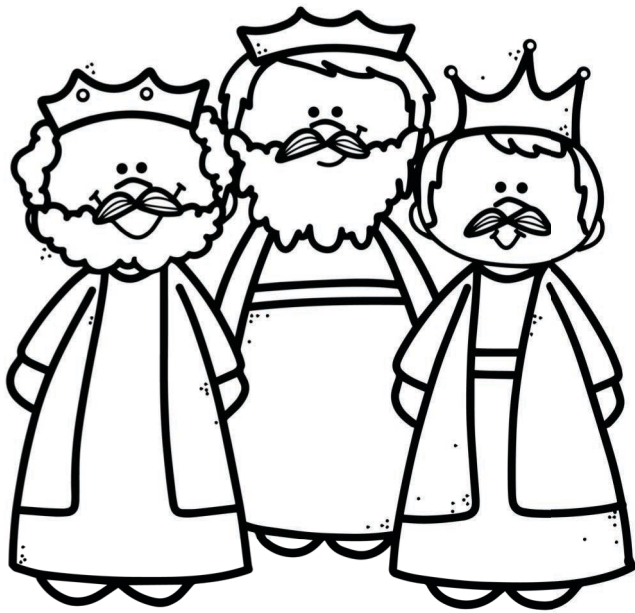

MAGI

©Adventures of a 4th Grade Classroom

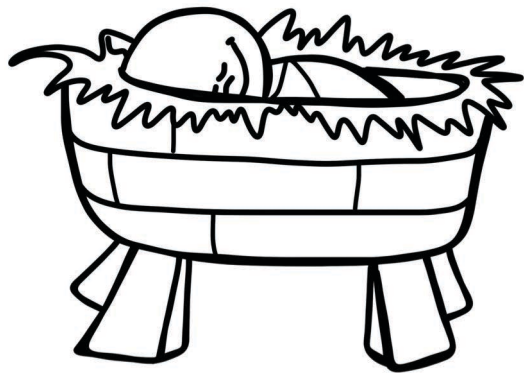

MANGER

©Adventures of a 4th Grade Classroom

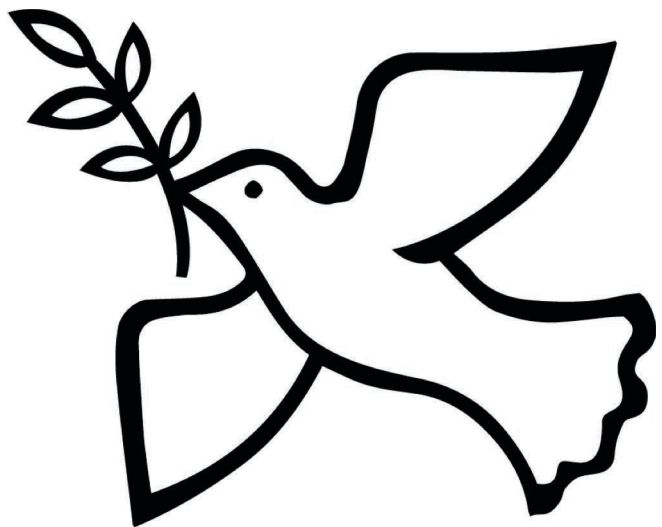

PEACE



PINK

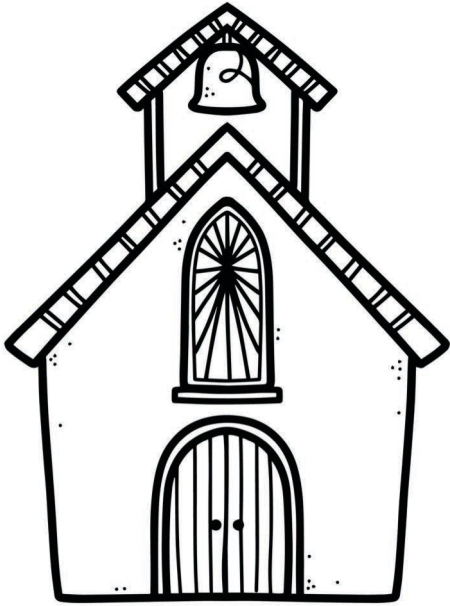

©Adventures of a 4th Grade Classroom

PREPARE



PURPLE

©Adventures of a 4th Grade Classroom



SHEPHERDS

©Adventures of a 4th Grade Classroom

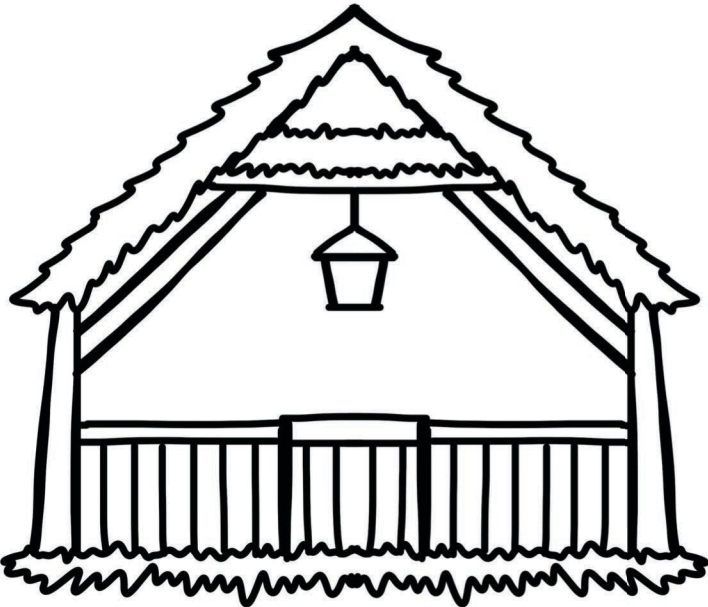

STABLE

©Adventures of a 4th Grade Classroom

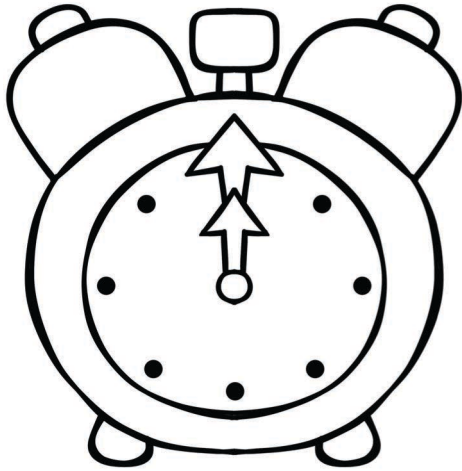

WAIT



WREATH